

TYPICAL RIDGE FLASHING DETAILS

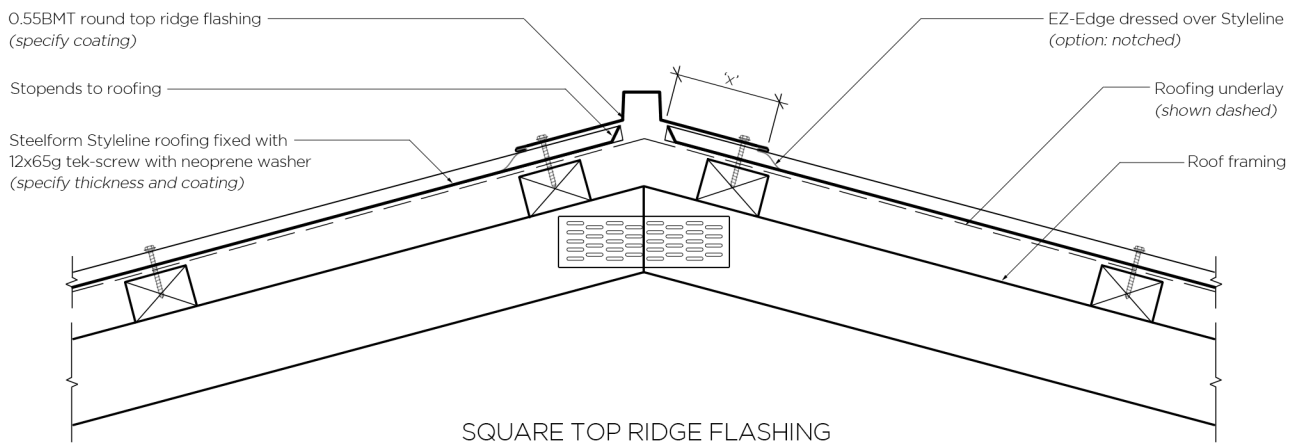

	SITUATION 1 LOW/MEDIUM/HIGH WIND ZONES, AND ROOF PITCH IS 10° AND ABOVE	SITUATION 2 VERY HIGH WIND ZONE, ALL ROOF PITCHES	SITUATION 3 EXTRA HIGH WIND ZONE, ALL ROOF PITCHES
'x' =	min 130mm	min 200mm	min 200mm
PLEASE REFER TO E2/AS1 TABLE 7 FOR FURTHER INFORMATION ON FLASHING COVER WIDTHS STRUCTURE SHOWN FOR ILLUSTRATION PURPOSES ONLY			
	CATEGORY A LOW/MEDIUM/HIGH WIND ZONES, AND WHERE THE PITCH IS NO LESS THAN 10°	CATEGORY B VERY HIGH/EXTRA HIGH WIND ZONES, OR WHERE THE PITCH IS LESS THAN 10°	
'x' =	min 130mm	min 200mm	
PLEASE REFER TO MRM CODE OF PRACTICE VERSION 3.0 FOR FURTHER INFORMATION ON FLASHING COVER WIDTHS STRUCTURE SHOWN FOR ILLUSTRATION PURPOSES ONLY			

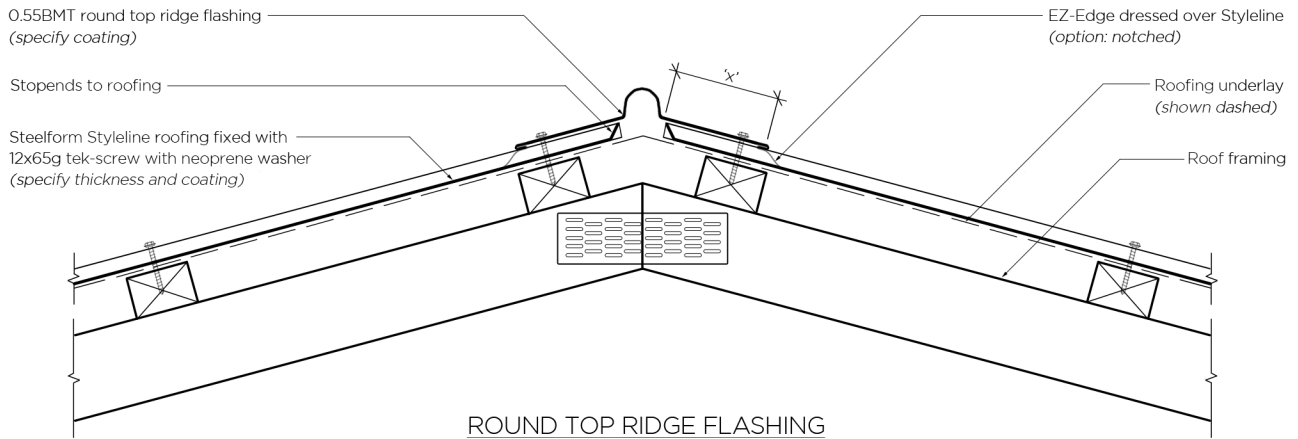

LONGRUN ROOFING MANUFACTURES

TARANAKI STEELFORMERS LTD.

STYLELINE

SEPTEMBER 2019 / VERSION 1

RESIDENTIAL ROOF TO TIMBER FRAMING

NOT TO SCALE

Disclaimer: All details are indicative only and the designer should consult both the NZMRM Code of Practice, E2 and all other relevant building codes. Details of the supporting mechanisms are indicative and compliance is the responsibility of the designer. Framing layout is for indicative purposes only. The underlay is detailed as a single line for simplicity and is indicative only. Building paper type and method of installation should comply with the manufacturers recommendations and NZBC regulations. Fixing requirements and patterns vary, see the NZMRM Code of Practice for more information. Foam closure strip required if bird or vermin proofing is required, or if in a high wind zone, there is a risk of wind blown moisture entering the building.

TYPICAL VALLEY FLASHING DETAIL

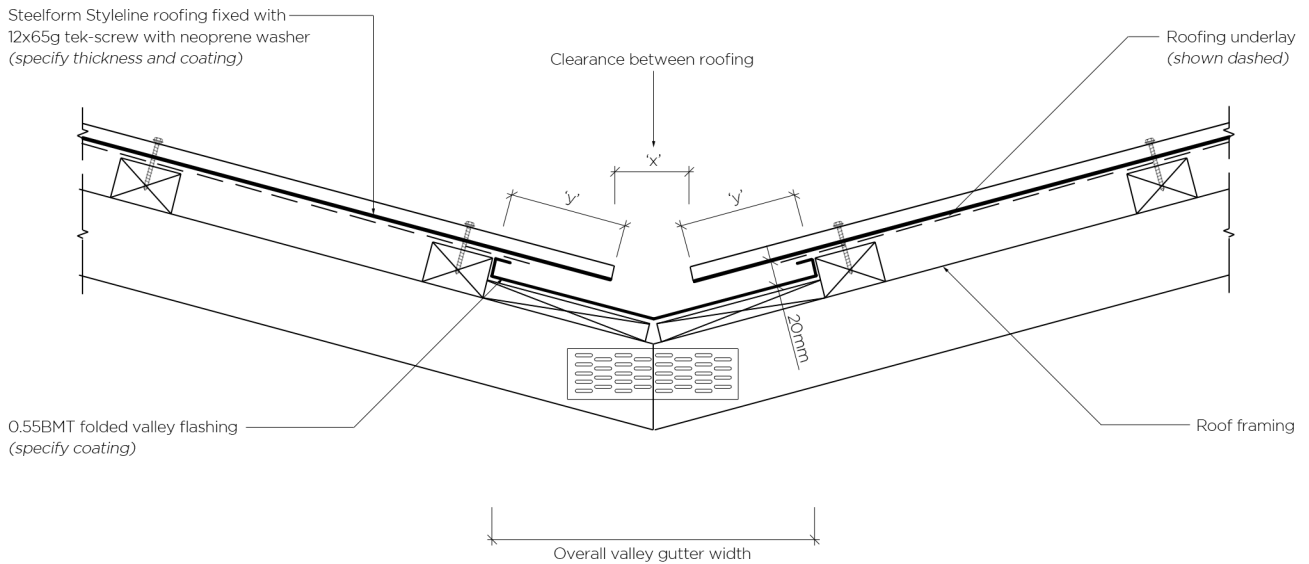

	<p>Max catchment 25m² *Min roof pitch 8°</p>
'x' =	min 50mm
'y' =	min 80mm
'z' =	min 250mm
	<p>*For roof pitches below 8°, refer to E2/AS1 or MRM Code of Practice (v3)</p>
<p>PLEASE REFER TO E2/AS1 FOR FURTHER INFORMATION ON FLASHING COVER WIDTHS STRUCTURE SHOWN FOR ILLUSTRATION PURPOSES ONLY</p>	



LONGRUN ROOFING MANUFACTURES

TARANAKI STEELFORMERS LTD.

STYLELINE

SEPTEMBER 2019 / VERSION 1

RESIDENTIAL ROOF TO TIMBER FRAMING

NOT TO SCALE

Disclaimer: All details are indicative only and the designer should consult both the NZMRM Code of Practice, E2 and all other relevant building codes. Details of the supporting mechanisms are indicative and compliance is the responsibility of the designer. Framing layout is for indicative purposes only. The underlay is detailed as a single line for simplicity and is indicative only. Building paper type and method of installation should comply with the manufacturers recommendations and NZBC regulations. Fixing requirements and patterns vary, see the NZMRM Code of Practice for more information. Foam closure strip only required if bird or vermin proofing is required, or if in a high wind zone, there is a risk of wind blown moisture entering the building.

TYPICAL BARGE FLASHING DETAIL

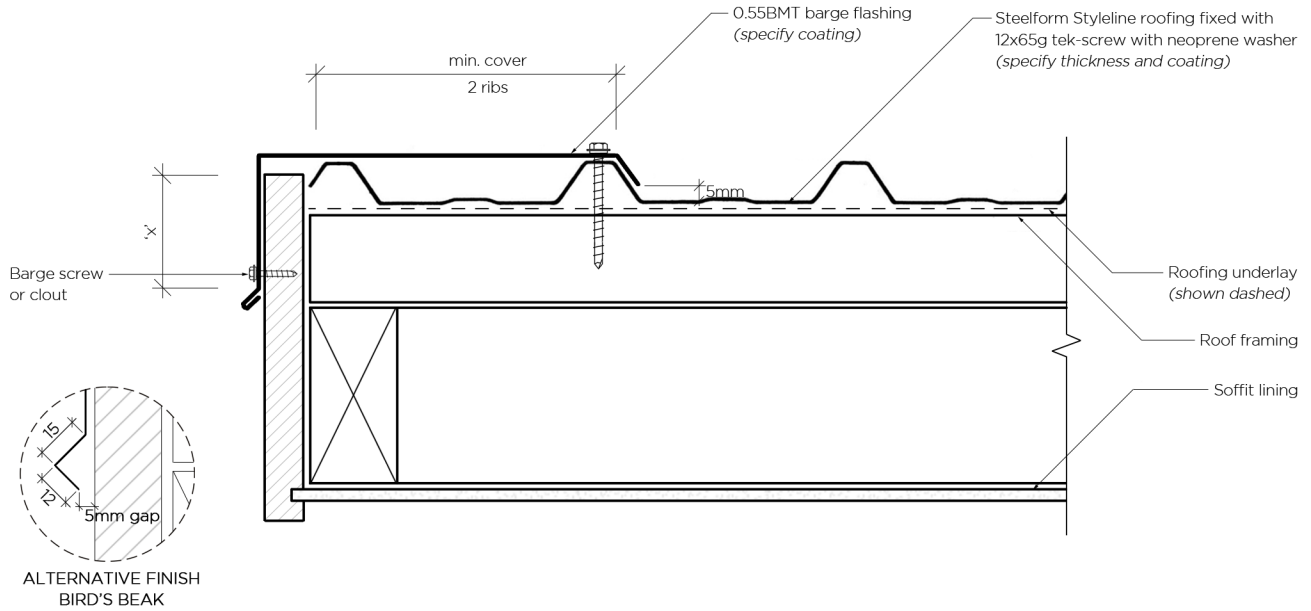

	SITUATION 1 LOW/MEDIUM/HIGH WIND ZONES, AND ROOF PITCH IS 10° AND ABOVE	SITUATION 2 VERY HIGH WIND ZONE, ALL ROOF PITCHES	SITUATION 3 EXTRA HIGH WIND ZONE, ALL ROOF PITCHES
'x' =	50mm	70mm	90mm
PLEASE REFER TO E2/AS1 TABLE 7 FOR FURTHER INFORMATION ON FLASHING COVER WIDTHS STRUCTURE SHOWN FOR ILLUSTRATION PURPOSES ONLY			
'x' =	<p>CATEGORY A LOW/MEDIUM/HIGH WIND ZONES, AND WHERE THE PITCH IS NO LESS THAN 10°</p> <p>Vertically down face (smooth) = min 50mm Vertically down face (profiled) = min 75mm</p>	<p>CATEGORY B VERY HIGH/EXTRA HIGH WIND ZONES, OR WHERE THE PITCH IS LESS THAN 10°</p> <p>Vertically down face (smooth) = min 75mm Vertically down face (profiled) = min 100mm</p>	
PLEASE REFER TO MRM CODE OF PRACTICE VERSION 3.0 FOR FURTHER INFORMATION ON FLASHING COVER WIDTHS STRUCTURE SHOWN FOR ILLUSTRATION PURPOSES ONLY			



LONGRUN ROOFING MANUFACTURES
TARANAKI STEELFORMERS LTD.

STYLELINE

SEPTEMBER 2019 / VERSION 1

RESIDENTIAL ROOF TO TIMBER FRAMING

NOT TO SCALE

Disclaimer:
All details are indicative only and the designer should consult both the NZMRM Code of Practice, E2 and all other relevant building codes. Details of the supporting mechanisms are indicative and compliance is the responsibility of the designer. Framing layout is for indicative purposes only. The underlay is detailed as a single line for simplicity and is indicative only. Building paper type and method of installation should comply with the manufacturers recommendations and NZBC regulations. Fixing requirements and patterns vary, see the NZMRM Code of Practice for more information. Foam closure strip only required if bird or vermin proofing is required, or if in a high wind zone, there is a risk of wind blown moisture entering the building.

TYPICAL HEAD BARGE FLASHING DETAIL

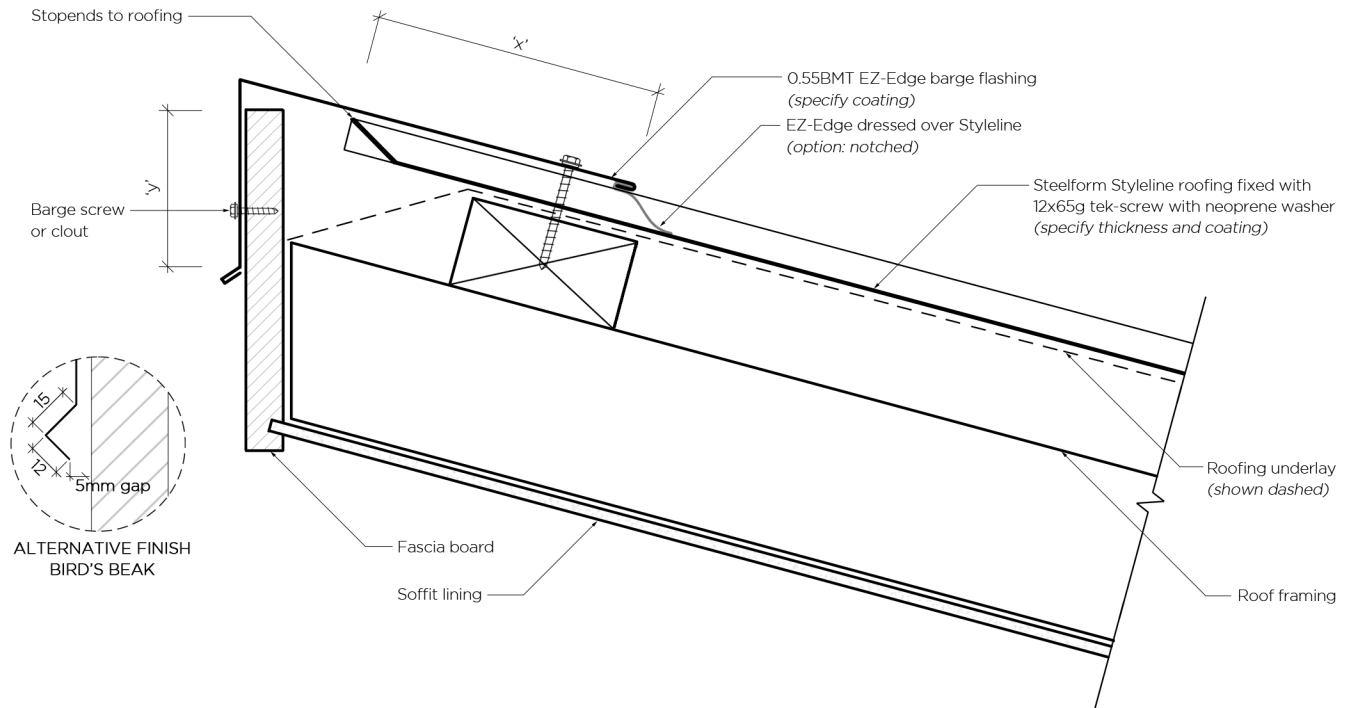

	SITUATION 1 LOW/MEDIUM/HIGH WIND ZONES, AND ROOF PITCH IS 10° AND ABOVE	SITUATION 2 VERY HIGH WIND ZONE, ALL ROOF PITCHES	SITUATION 3 EXTRA HIGH WIND ZONE, ALL ROOF PITCHES
'x' =	min 130mm	min 200mm	min 200mm
'y' =	min 50mm	min 70mm	min 90mm
PLEASE REFER TO E2/AS1 TABLE 7 FOR FURTHER INFORMATION ON FLASHING COVER WIDTHS STRUCTURE SHOWN FOR ILLUSTRATION PURPOSES ONLY			
	<p style="text-align: center;">CATEGORY A LOW/MEDIUM/HIGH WIND ZONES, AND WHERE THE PITCH IS NO LESS THAN 10°</p>	<p style="text-align: center;">CATEGORY B VERY HIGH/EXTRA HIGH WIND ZONES, OR WHERE THE PITCH IS LESS THAN 10°</p>	
'x' =	min 130mm	min 200mm	
'y' =	Vertically down face (smooth) = min 50mm Vertically down face (profiled) = min 75mm	Vertically down face (smooth) = min 75mm Vertically down face (profiled) = min 100mm	
PLEASE REFER TO MRM CODE OF PRACTICE VERSION 3.0 FOR FURTHER INFORMATION ON FLASHING COVER WIDTHS STRUCTURE SHOWN FOR ILLUSTRATION PURPOSES ONLY			



LONGRUN ROOFING MANUFACTURES

TARANAKI STEELFORMERS LTD.

STYLELINE

SEPTEMBER 2019 / VERSION 1

RESIDENTIAL ROOF TO TIMBER FRAMING

NOT TO SCALE

Disclaimer: All details are indicative only and the designer should consult both the NZMRM Code of Practice, E2 and all other relevant building codes. Details of the supporting mechanisms are indicative and compliance is the responsibility of the designer. Framing layout is for indicative purposes only. The underlay is detailed as a single line for simplicity and is indicative only. Building paper type and method of installation should comply with the manufacturers recommendations and NZBC regulations. Fixing requirements and patterns vary, see the NZMRM Code of Practice for more information. Foam closure strip only required if bird or vermin proofing is required, or if in a high wind zone, there is a risk of wind blown moisture entering the building.

TYPICAL APRON FLASHING DETAIL

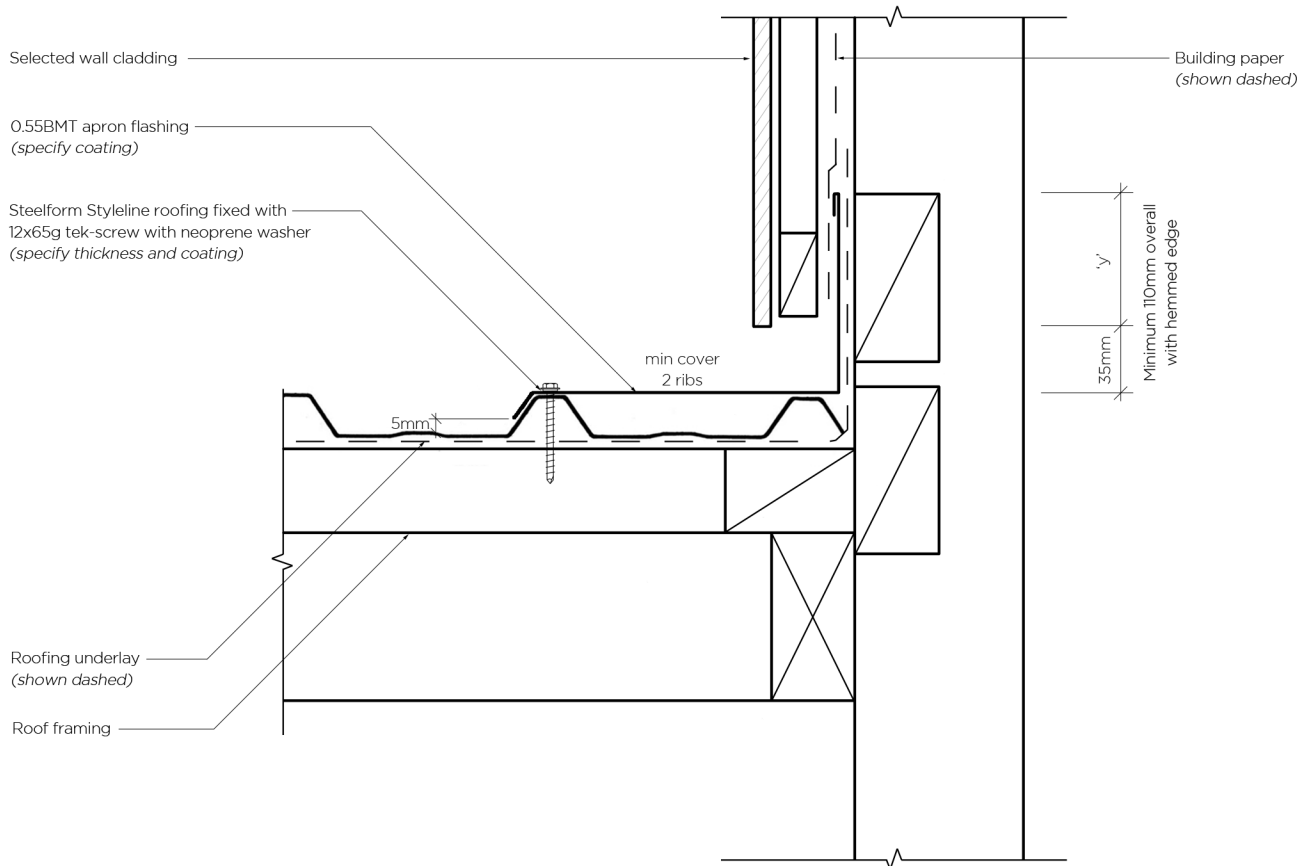

	SITUATION 1 LOW/MEDIUM/HIGH WIND ZONES, AND ROOF PITCH IS 10° AND ABOVE	SITUATION 2 VERY HIGH WIND ZONE, ALL ROOF PITCHES	SITUATION 3 EXTRA HIGH WIND ZONE, ALL ROOF PITCHES
'y' =	min 75mm	min 75mm	min 75mm
PLEASE REFER TO E2/AS1 TABLE 7 FOR FURTHER INFORMATION ON FLASHING COVER WIDTHS STRUCTURE SHOWN FOR ILLUSTRATION PURPOSES ONLY			
	CATEGORY A LOW/MEDIUM/HIGH WIND ZONES, AND WHERE THE PITCH IS NO LESS THAN 10°	CATEGORY B VERY HIGH/EXTRA HIGH WIND ZONES, OR WHERE THE PITCH IS LESS THAN 10°	
'y' =	Vertically up face (smooth) = min 50mm Vertically up face (profiled) = min 75mm	Vertically up face (smooth) = min 75mm Vertically up face (profiled) = min 100mm	
PLEASE REFER TO MRM CODE OF PRACTICE VERSION 3.0 FOR FURTHER INFORMATION ON FLASHING COVER WIDTHS STRUCTURE SHOWN FOR ILLUSTRATION PURPOSES ONLY			



LONGRUN ROOFING MANUFACTURES

TARANAKI STEELFORMERS LTD.

STYLELINE

SEPTEMBER 2019 / VERSION 1

RESIDENTIAL ROOF TO TIMBER FRAMING

NOT TO SCALE

Disclaimer: All details are indicative only and the designer should consult both the NZMRM Code of Practice, E2 and all other relevant building codes. Details of the supporting mechanisms are indicative and compliance is the responsibility of the designer. Framing layout is for indicative purposes only. The underlay is detailed as a single line for simplicity and is indicative only. Building paper type and method of installation should comply with the manufacturers recommendations and NZBC regulations. Fixing requirements and patterns vary, see the NZMRM Code of Practice for more information. Foam closure strip only required if bird or vermin proofing is required, or if in a high wind zone, there is a risk of wind blown moisture entering the building.

TYPICAL HEAD APRON FLASHING DETAIL

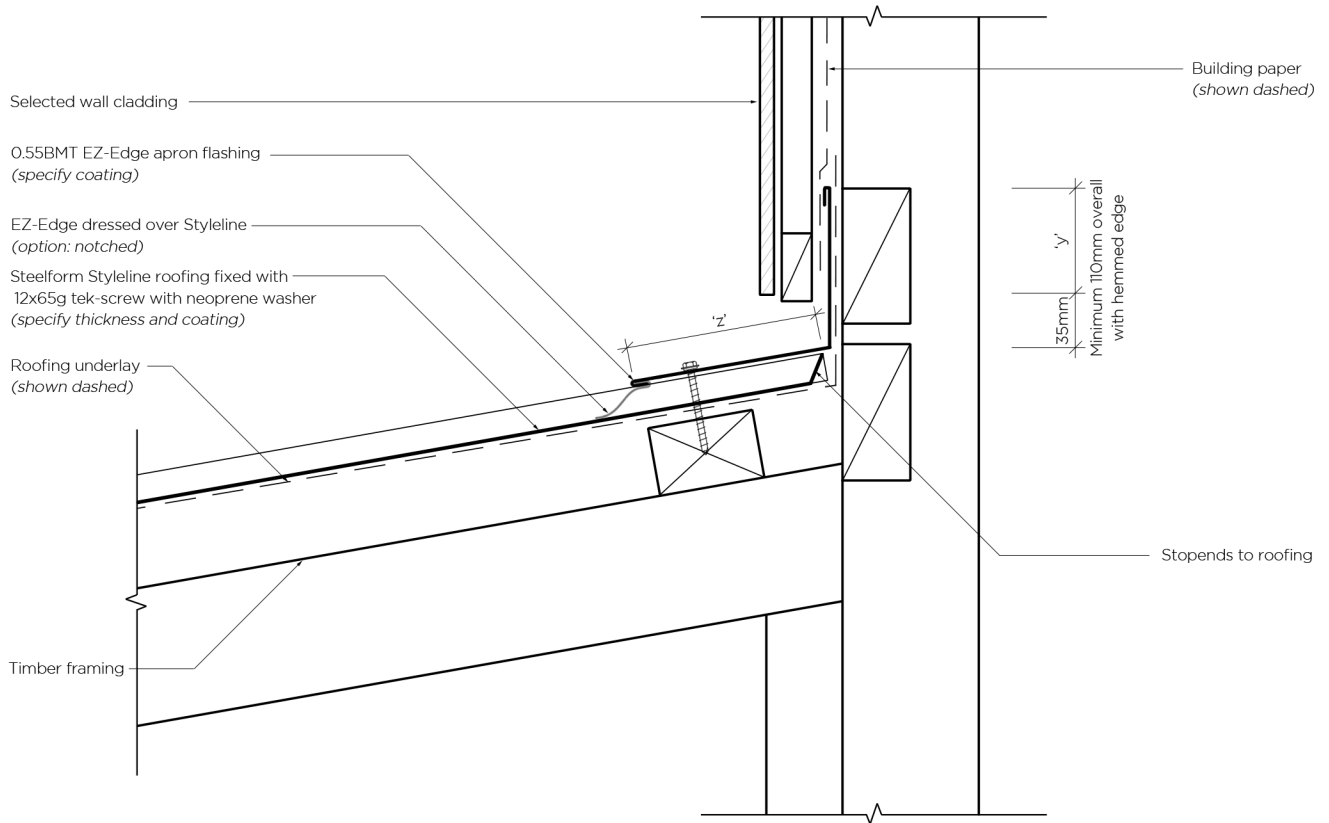

	SITUATION 1 LOW/MEDIUM/HIGH WIND ZONES, AND ROOF PITCH IS 10° AND ABOVE	SITUATION 2 VERY HIGH WIND ZONE, ALL ROOF PITCHES	SITUATION 3 EXTRA HIGH WIND ZONE, ALL ROOF PITCHES
'y' =	min 75mm	min 75mm	min 75mm
'z' =	min 130mm	min 200mm	min 200mm
PLEASE REFER TO E2/AS1 TABLE 7 FOR FURTHER INFORMATION ON FLASHING COVER WIDTHS STRUCTURE SHOWN FOR ILLUSTRATION PURPOSES ONLY			
	CATEGORY A LOW/MEDIUM/HIGH WIND ZONES, AND WHERE THE PITCH IS NO LESS THAN 10°	CATEGORY B VERY HIGH/EXTRA HIGH WIND ZONES, OR WHERE THE PITCH IS LESS THAN 10°	
'y' =	Vertically up face (smooth) = min 50mm Vertically up face (profiled) = min 75mm	Vertically up face (smooth) = min 75mm Vertically up face (profiled) = min 100mm	
'z' =	min 150mm	min 200mm	
PLEASE REFER TO MRM CODE OF PRACTICE VERSION 3.0 FOR FURTHER INFORMATION ON FLASHING COVER WIDTHS STRUCTURE SHOWN FOR ILLUSTRATION PURPOSES ONLY			



LONGRUN ROOFING MANUFACTURES

TARANAKI STEELFORMERS LTD.

STYLELINE

SEPTEMBER 2019 / VERSION 1

RESIDENTIAL ROOF TO TIMBER FRAMING

NOT TO SCALE

Disclaimer: All details are indicative only and the designer should consult both the NZMRM Code of Practice, E2 and all other relevant building codes. Details of the supporting mechanisms are indicative and compliance is the responsibility of the designer. Framing layout is for indicative purposes only. The underlay is detailed as a single line for simplicity and is indicative only. Building paper type and method of installation should comply with the manufacturers recommendations and NZBC regulations. Fixing requirements and patterns vary, see the NZMRM Code of Practice for more information. Foam closure strip only required if bird or vermin proofing is required, or if in a high wind zone, there is a risk of wind blown moisture entering the building.

TYPICAL DRIP EDGE FLASHING DETAIL

Required where all of the following conditions are met:

- Roof pitch is equal to or less than 10°
- Soffit width is less than or equal to 100mm, and
- Wind zone is very high or extra high

(E2/AS1, Figure 45)

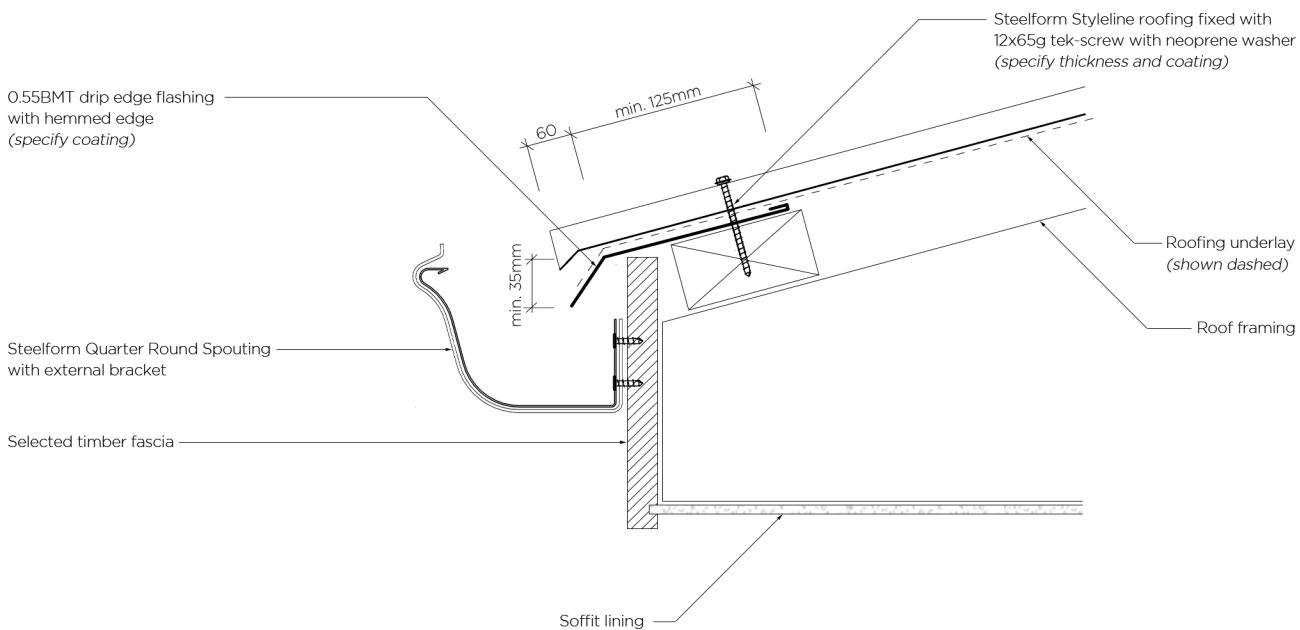
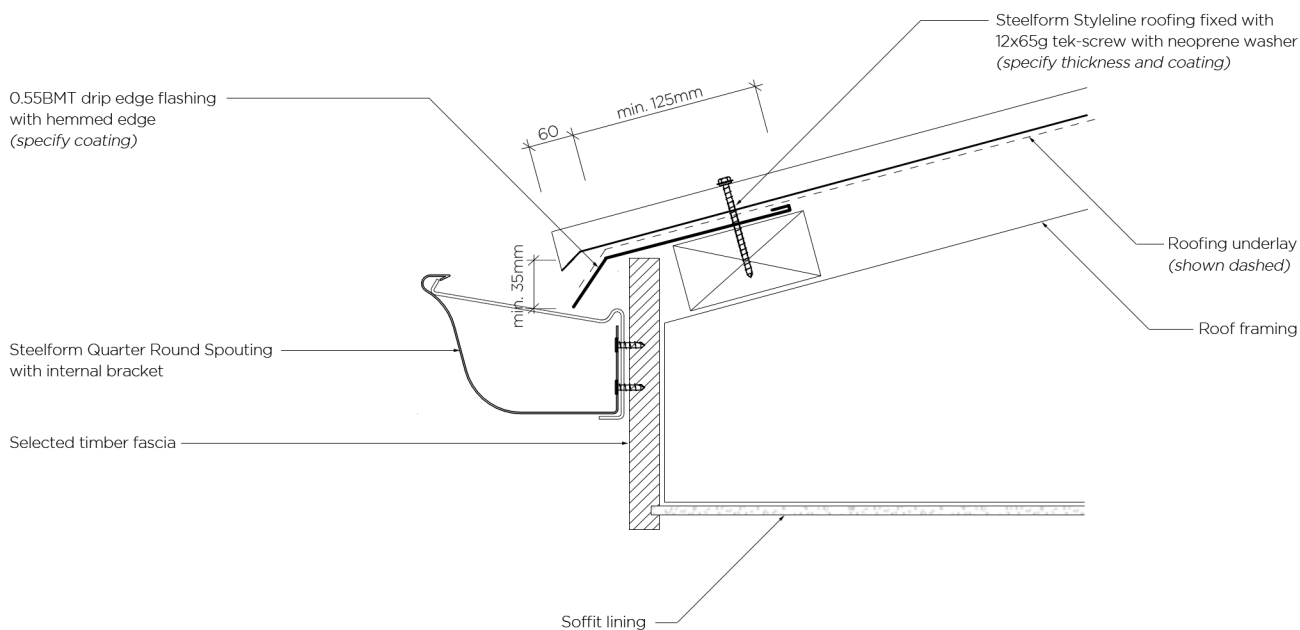

LONGRUN ROOFING MANUFACTURES

TARANAKI STEELFORMERS LTD.

STYLELINE

SEPTEMBER 2019 / VERSION 1

RESIDENTIAL ROOF TO TIMBER FRAMING

NOT TO SCALE

Disclaimer: All details are indicative only and the designer should consult both the NZMRM Code of Practice, E2 and all other relevant building codes. Details of the supporting mechanisms are indicative and compliance is the responsibility of the designer. Framing layout is for indicative purposes only. The underlay is detailed as a single line for simplicity and is indicative only. Building paper type and method of installation should comply with the manufacturers recommendations and NZBC regulations. Fixing requirements and patterns vary, see the NZMRM Code of Practice for more information. Foam closure strip only required if bird or vermin proofing is required, or if in a high wind zone, there is a risk of wind blown moisture entering the building.

TYPICAL CHANGE OF PITCH FLASHING DETAIL

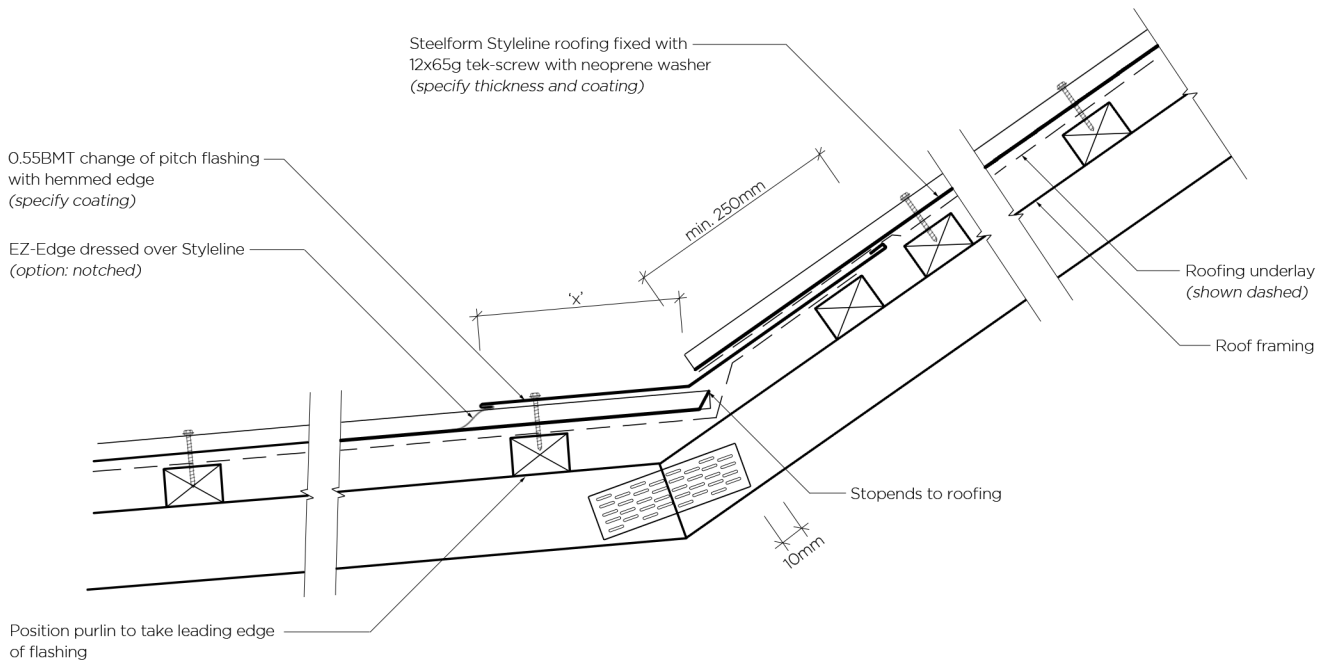

	<p>SITUATION 1 LOW/MEDIUM/HIGH WIND ZONES, AND ROOF PITCH IS 10° AND ABOVE</p>	<p>SITUATION 2 VERY HIGH WIND ZONE, ALL ROOF PITCHES</p>	<p>SITUATION 3 EXTRA HIGH WIND ZONE, ALL ROOF PITCHES</p>
'x' =	min 130mm	min 200mm	<i>not allowed</i>
PLEASE REFER TO E2/AS1 TABLE 7 FOR FURTHER INFORMATION ON FLASHING COVER WIDTHS STRUCTURE SHOWN FOR ILLUSTRATION PURPOSES ONLY			
	<p>CATEGORY A LOW/MEDIUM/HIGH WIND ZONES, AND WHERE THE PITCH IS NO LESS THAN 10°</p>	<p>CATEGORY B VERY HIGH/EXTRA HIGH WIND ZONES, OR WHERE THE PITCH IS LESS THAN 10°</p>	
'x' =	min 150mm	min 200mm	
PLEASE REFER TO MRM CODE OF PRACTICE VERSION 3.0 FOR FURTHER INFORMATION ON FLASHING COVER WIDTHS STRUCTURE SHOWN FOR ILLUSTRATION PURPOSES ONLY			



LONGRUN ROOFING MANUFACTURES
TARANAKI STEELFORMERS LTD.

STYLELINE

SEPTEMBER 2019 / VERSION 1

RESIDENTIAL ROOF TO TIMBER FRAMING

NOT TO SCALE

Disclaimer:
All details are indicative only and the designer should consult both the NZMRM Code of Practice, E2 and all other relevant building codes. Details of the supporting mechanisms are indicative and compliance is the responsibility of the designer. Framing layout is for indicative purposes only. The underlay is detailed as a single line for simplicity and is indicative only. Building paper type and method of installation should comply with the manufacturers recommendations and NZBC regulations. Fixing requirements and patterns vary, see the NZMRM Code of Practice for more information. Foam closure strip only required if bird or vermin proofing is required, or if in a high wind zone, there is a risk of wind blown moisture entering the building.

TYPICAL INTERNAL GUTTER DETAILS

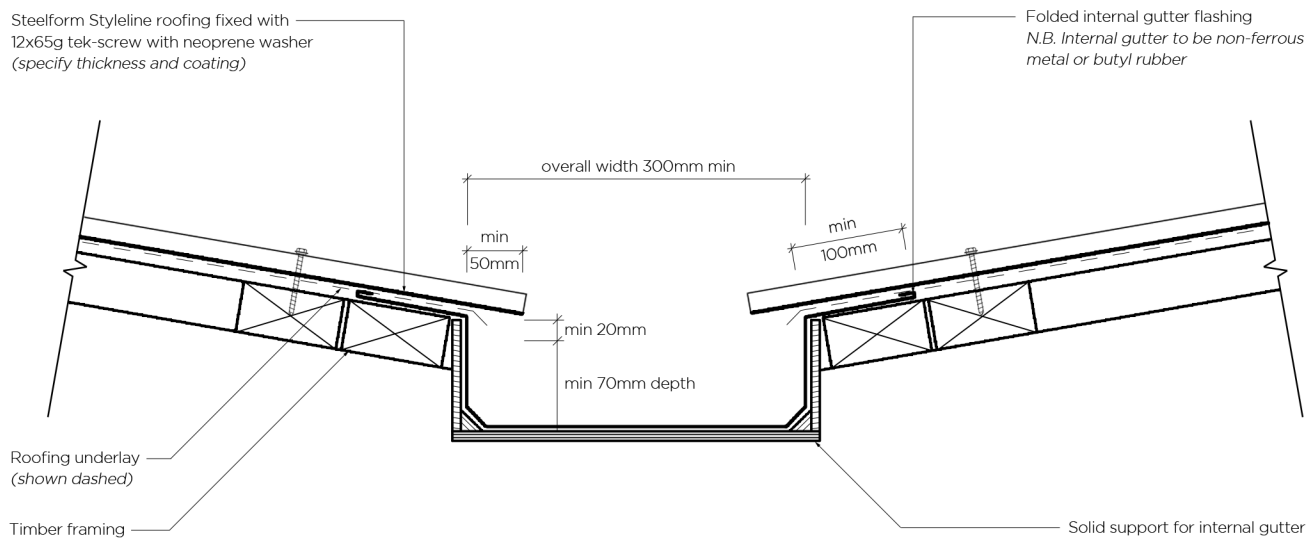
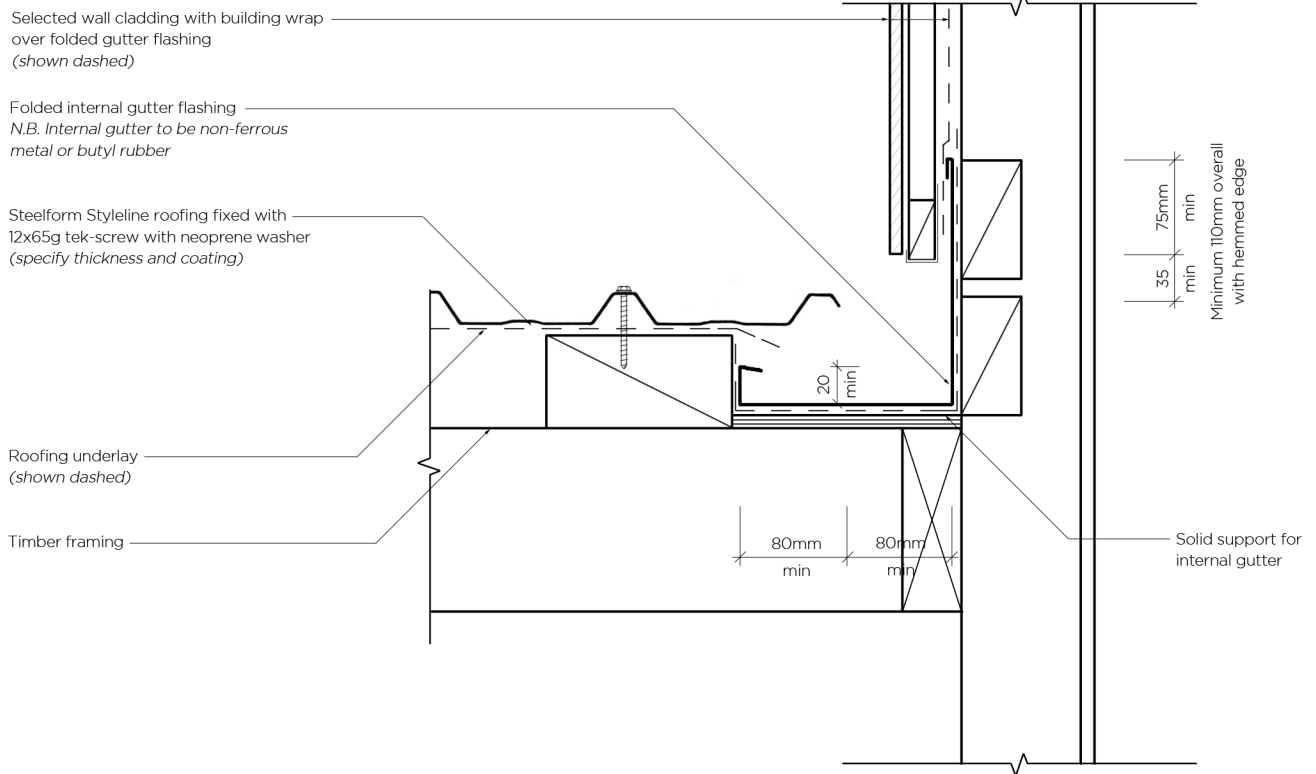

LONGRUN ROOFING MANUFACTURES
TARANAKI STEELFORMERS LTD.

STYLELINE

SEPTEMBER 2019 / VERSION 1

RESIDENTIAL ROOF TO TIMBER FRAMING

NOT TO SCALE

Disclaimer: All details are indicative only and the designer should consult both the NZMRM Code of Practice, E2 and all other relevant building codes. Details of the supporting mechanisms are indicative and compliance is the responsibility of the designer. Framing layout is for indicative purposes only. The underlay is detailed as a single line for simplicity and is indicative only. Building paper type and method of installation should comply with the manufacturers recommendations and NZBC regulations. Fixing requirements and patterns vary, see the NZMRM Code of Practice for more information. Foam closure strip required if bird or vermin proofing is required, or if in a high wind zone, there is a risk of wind blown moisture entering the building.

TYPICAL INTERNAL CORNER FLASHING DETAIL

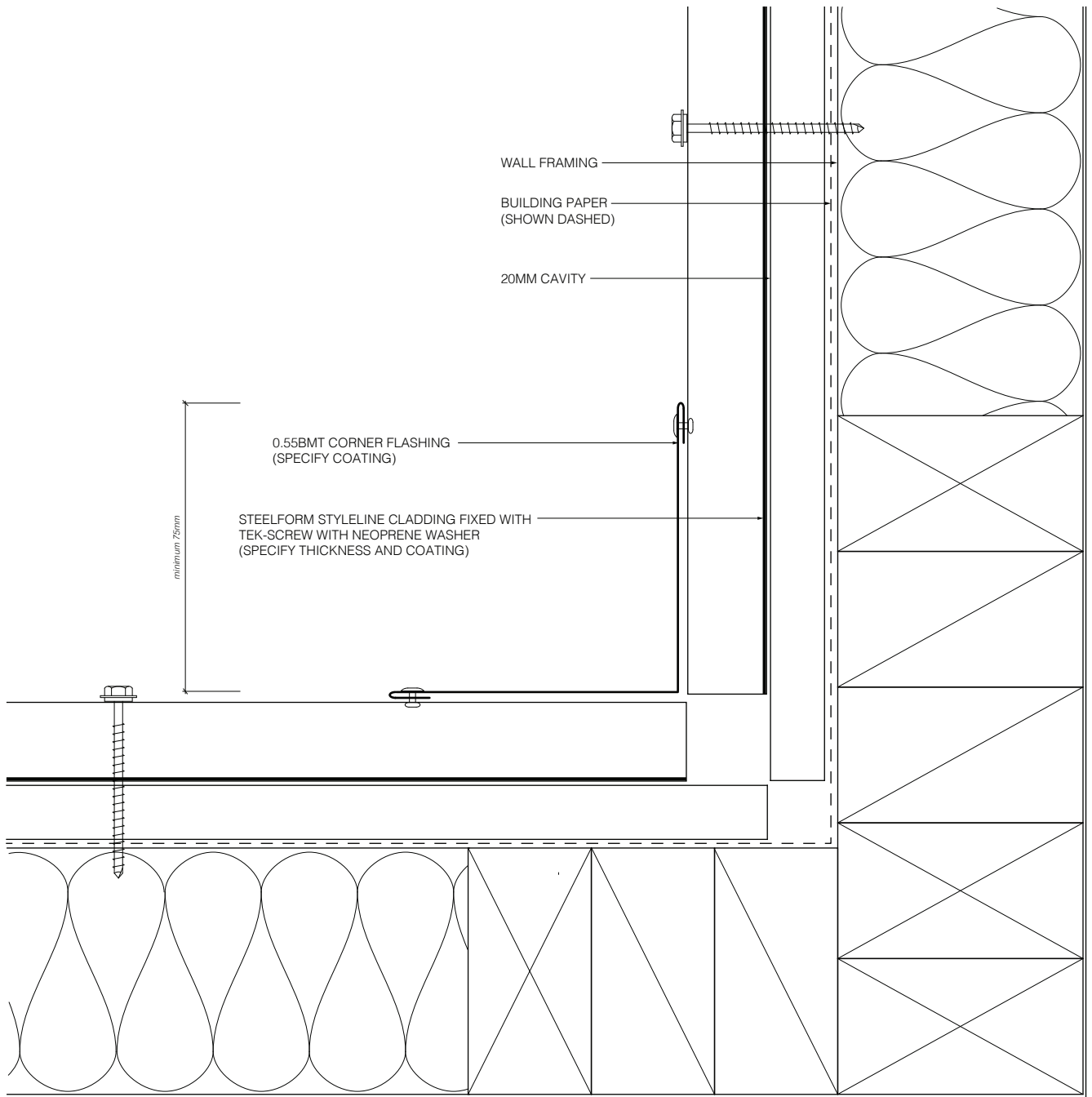

LONGRUN ROOFING MANUFACTURES
TARANAKI STEELFORMERS LTD.

STYLELINE (CAVITY FIX)

JANUARY 2020 / V1

RESIDENTIAL HORIZONTAL CLADDING

NOT TO SCALE

Disclaimer:
 All details are indicative only and the designer should refer to the NZMRM Code of Practice, E2/AS1 and all other relevant building codes. Details are indicative and compliance is the responsibility of the designer. Construction details can vary for wall cladding and framing layout is for indicative purposes only. The building paper is detailed as a single line for simplicity and is indicative only. Building paper type and method of installation should comply with the manufacturers recommendations and the New Zealand Building Code regulations. Profile foam closure strip is only required if bird or vermin proofing is required, or if in a high wind zone there is a risk of wind blown moisture entering the building.

TYPICAL INTERNAL CORNER FLASHING DETAIL

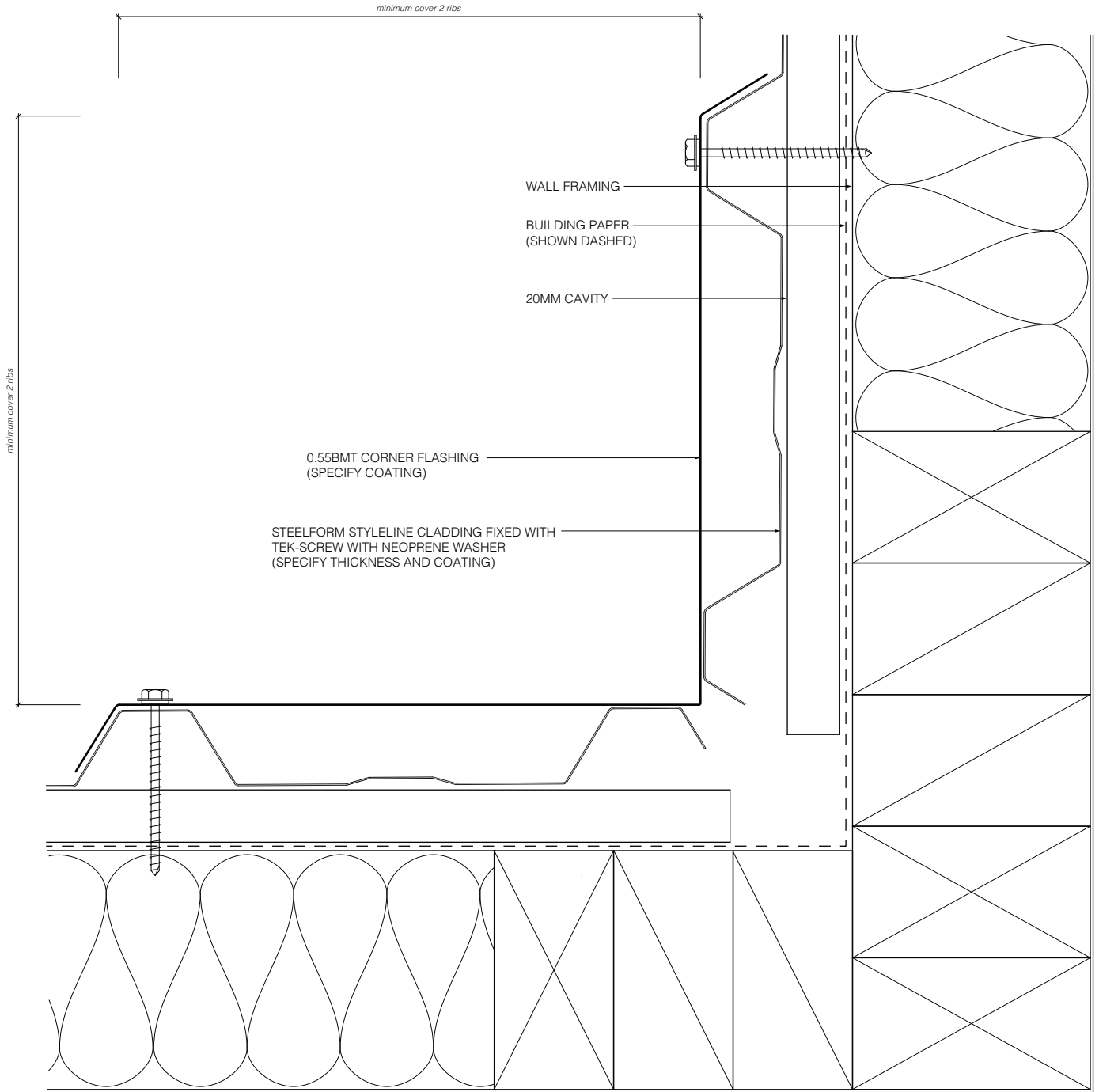

LONGRUN ROOFING MANUFACTURES
TARANAKI STEELFORMERS LTD.

STYLELINE (CAVITY FIX)

JANUARY 2020 / V1

RESIDENTIAL VERTICAL CLADDING

NOT TO SCALE

Disclaimer:
 All details are indicative only and the designer should refer to the NZMRM Code of Practice, E2/AS1 and all other relevant building codes. Details are indicative and compliance is the responsibility of the designer. Construction details can vary for wall cladding and framing layout is for indicative purposes only. The building paper is detailed as a single line for simplicity and is indicative only. Building paper type and method of installation should comply with the manufacturers recommendations and the New Zealand Building Code regulations. Profile foam closure strip is only required if bird or vermin proofing is required, or if in a high wind zone there is a risk of wind blown moisture entering the building.

TYPICAL EXTERNAL CORNER FLASHING DETAIL

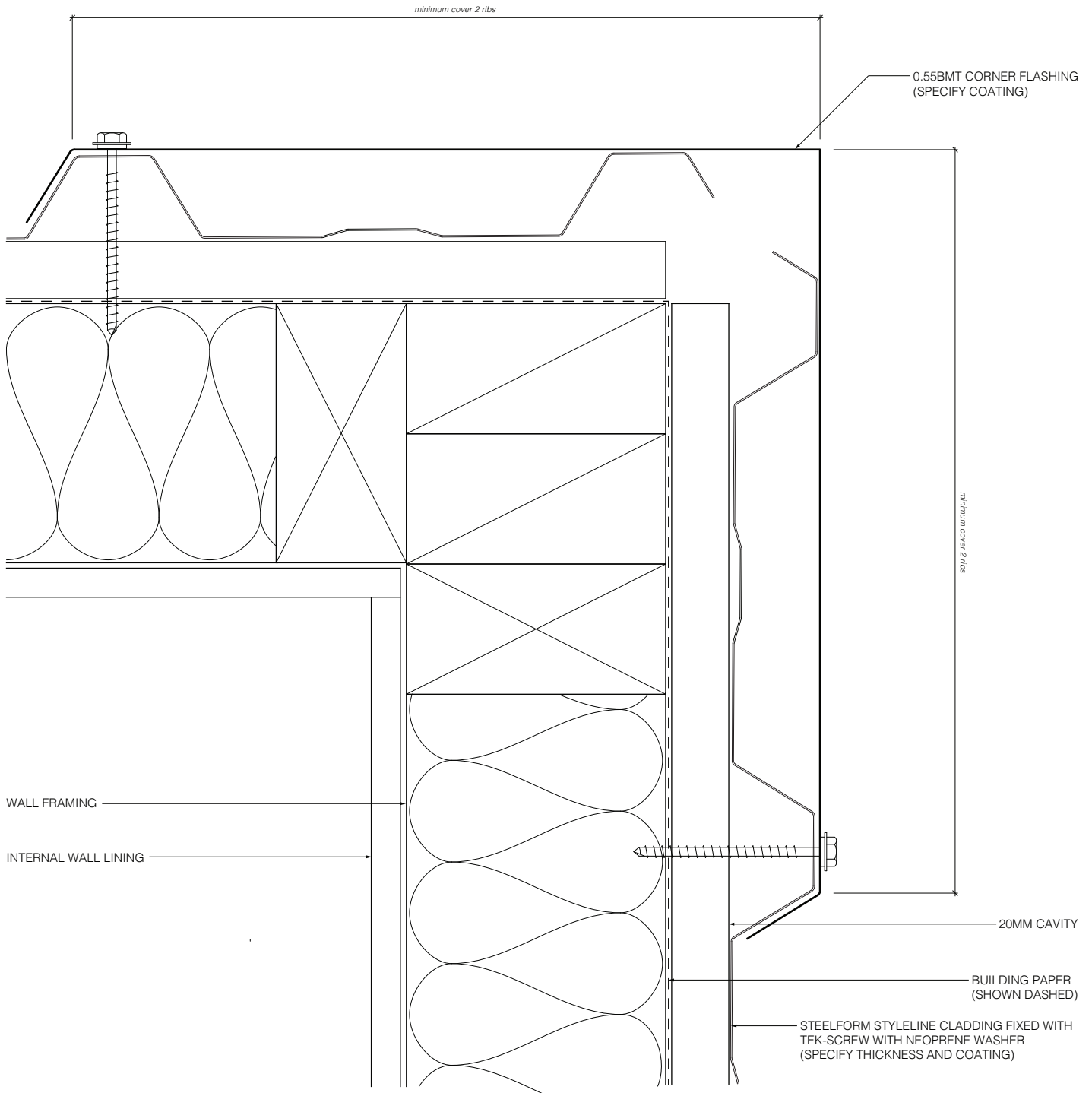

LONGRUN ROOFING MANUFACTURES
TARANAKI STEELFORMERS LTD.

STYLELINE (CAVITY FIX)

JANUARY 2020 / V1

RESIDENTIAL VERTICAL CLADDING

NOT TO SCALE

Disclaimer:
 All details are indicative only and the designer should refer to the NZMRM Code of Practice, E2/AS1 and all other relevant building codes. Details are indicative and compliance is the responsibility of the designer. Construction details can vary for wall cladding and framing layout is for indicative purposes only. The building paper is detailed as a single line for simplicity and is indicative only. Building paper type and method of installation should comply with the manufacturers recommendations and the New Zealand Building Code regulations. Profile foam closure strip is only required if bird or vermin proofing is required, or if in a high wind zone there is a risk of wind blown moisture entering the building.

TYPICAL EXTERNAL CORNER FLASHING DETAIL

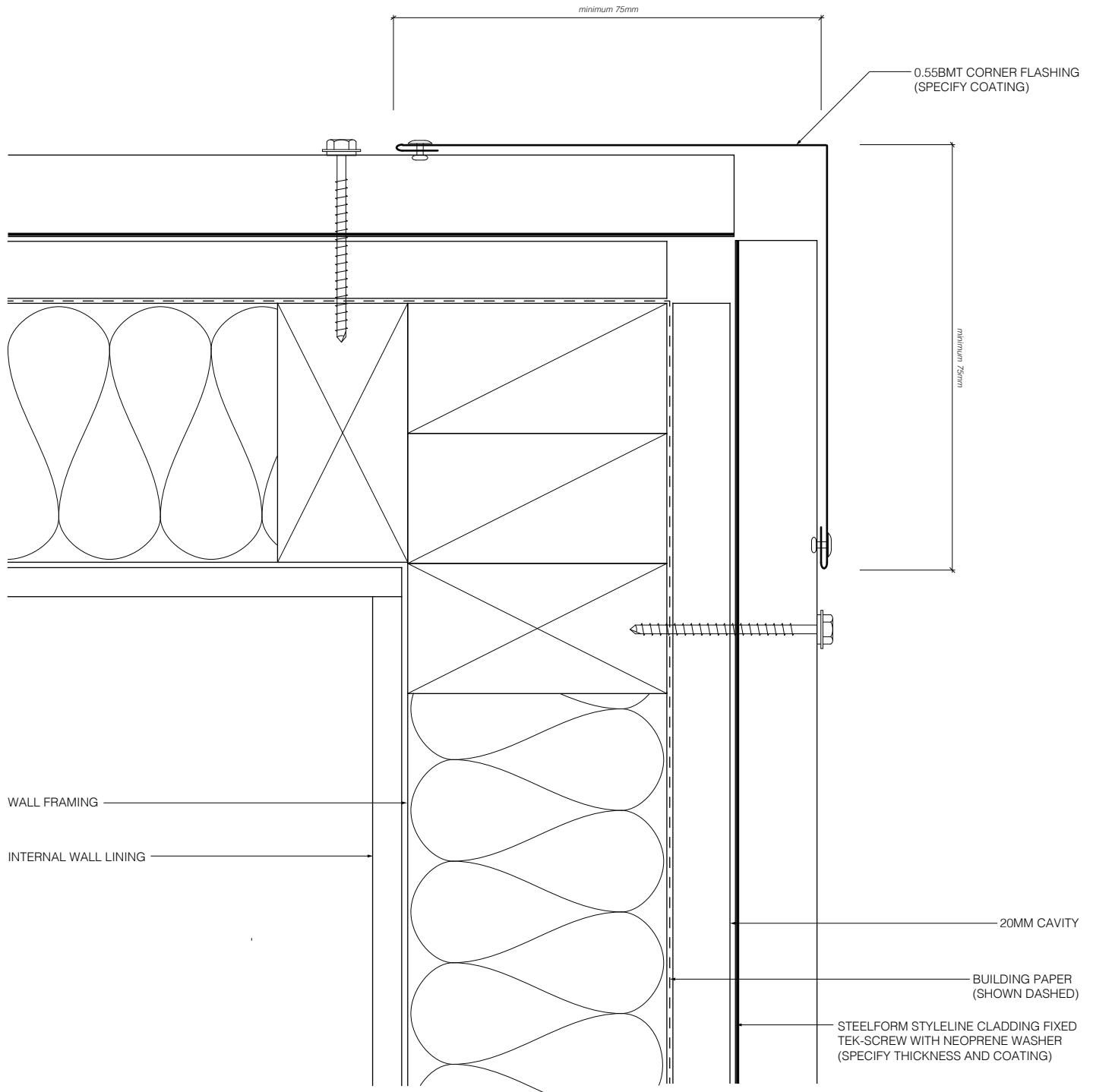

LONGRUN ROOFING MANUFACTURES
TARANAKI STEELFORMERS LTD.

STYLELINE (CAVITY FIX)

JANUARY 2020 / V1

RESIDENTIAL HORIZONTAL CLADDING

NOT TO SCALE

Disclaimer:
 All details are indicative only and the designer should refer to the NZMRM Code of Practice, E2/AS1 and all other relevant building codes. Details are indicative and compliance is the responsibility of the designer. Construction details can vary for wall cladding and framing layout is for indicative purposes only. The building paper is detailed as a single line for simplicity and is indicative only. Building paper type and method of installation should comply with the manufacturers recommendations and the New Zealand Building Code regulations. Profile foam closure strip is only required if bird or vermin proofing is required, or if in a high wind zone there is a risk of wind blown moisture entering the building.

TYPICAL BOTTOM FLASHING DETAIL

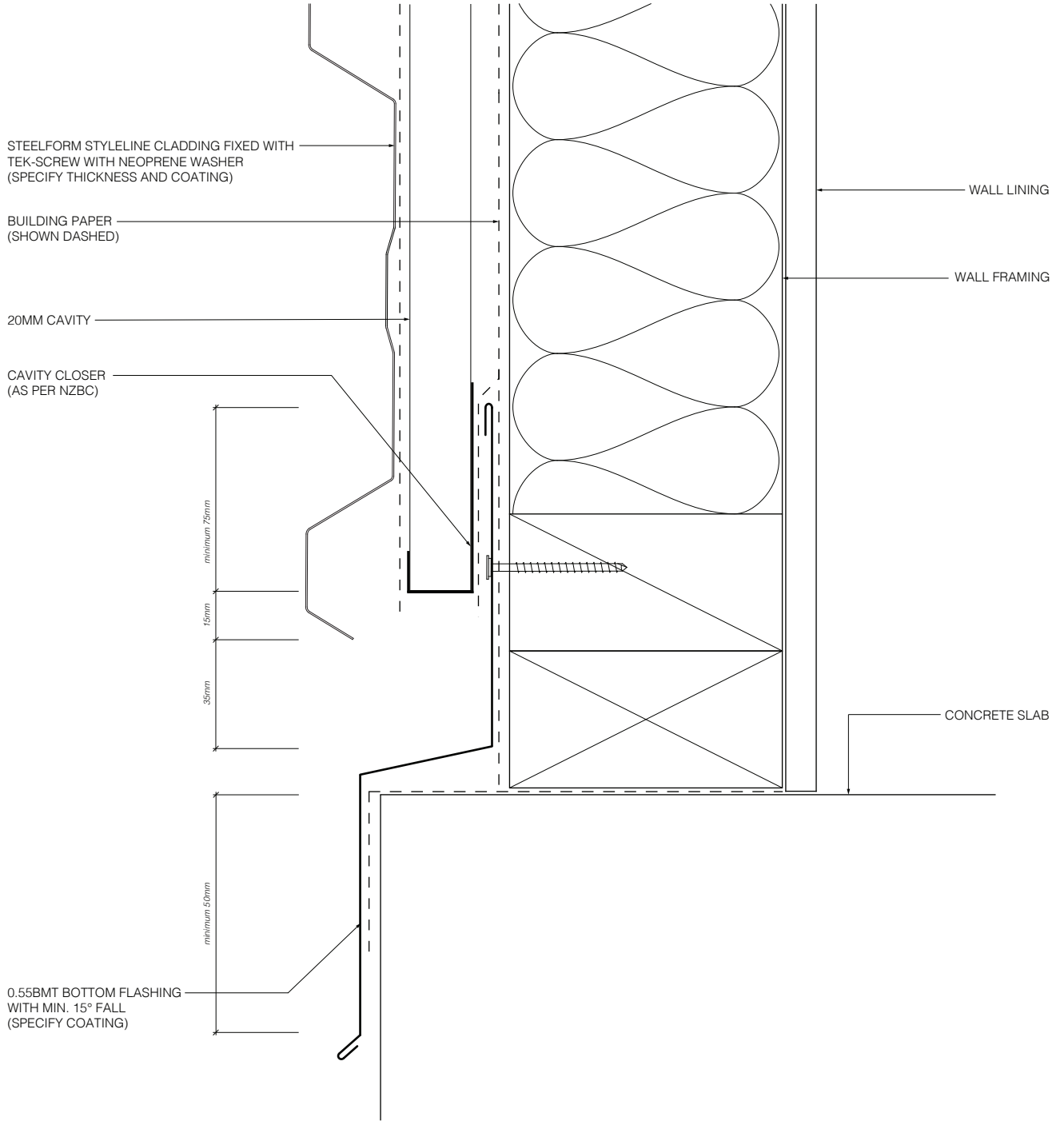

LONGRUN ROOFING MANUFACTURES
TARANAKI STEELFORMERS LTD.

JANUARY 2020 / V1

STYLELINE (CAVITY FIX)

RESIDENTIAL CLADDING

NOT TO SCALE

Disclaimer:
 All details are indicative only and the designer should refer to the NZMRM Code of Practice, E2/AS1 and all other relevant building codes. Details are indicative and compliance is the responsibility of the designer. Construction details can vary for wall cladding and framing layout is for indicative purposes only. The building paper is detailed as a single line for simplicity and is indicative only. Building paper type and method of installation should comply with the manufacturers recommendations and the New Zealand Building Code regulations. Profile foam closure strip is only required if bird or vermin proofing is required, or if in a high wind zone there is a risk of wind blown moisture entering the building.

TYPICAL EAVES FLASHING DETAIL

N.B. Eaves flashings are required where all of the following conditions are met:

- Roof slop is less than or equal to 10°, and
- soffit width is less than or equal to 100mm, and
- wind zones are Very High or Extra High

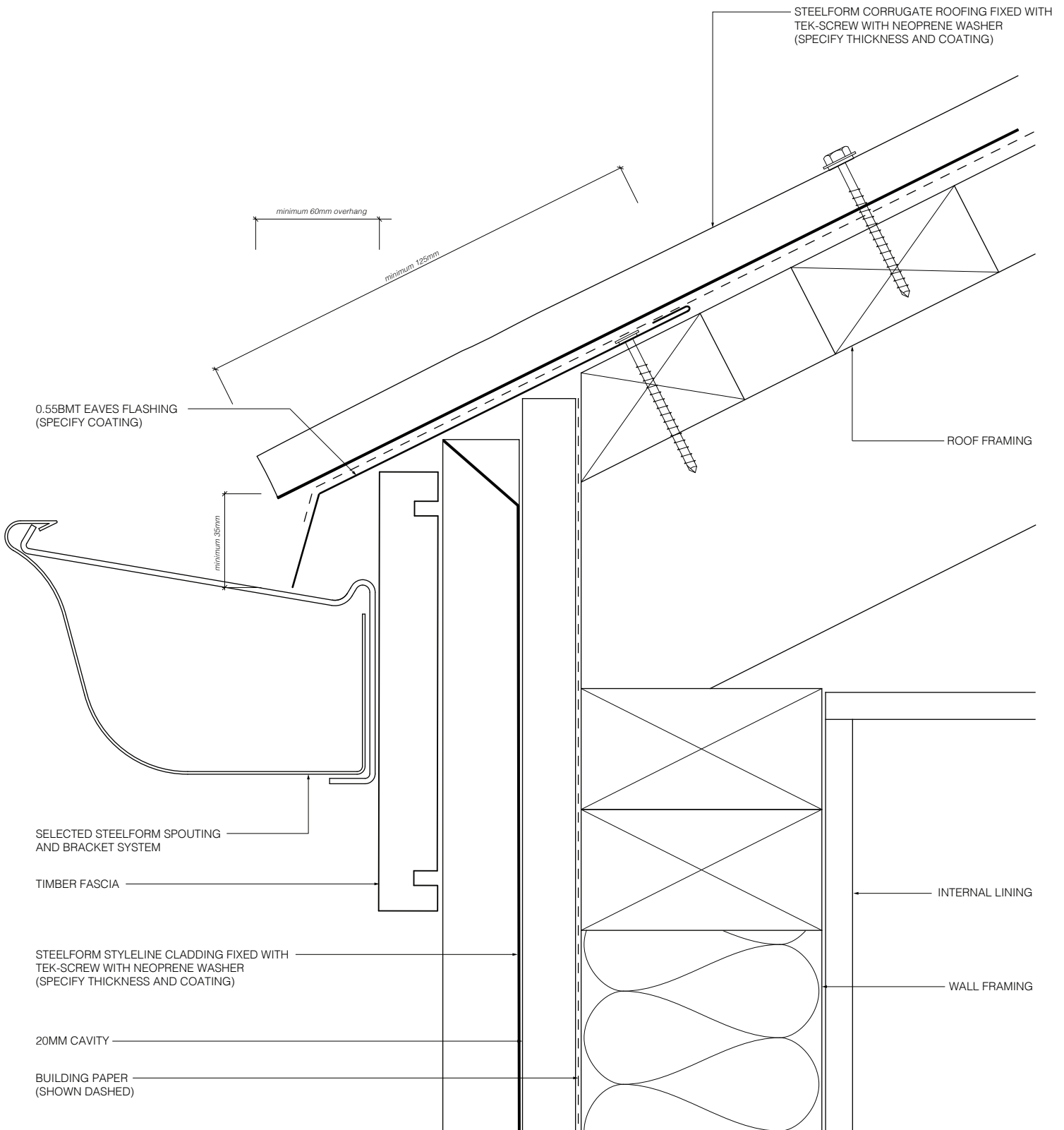

LONGRUN ROOFING MANUFACTURES

TARANAKI STEELFORMERS LTD.

JANUARY 2020 / V1

STYLELINE (CAVITY FIX)

RESIDENTIAL CLADDING

NOT TO SCALE

Disclaimer:
 All details are indicative only and the designer should refer to the NZMRM Code of Practice, E2/AS1 and all other relevant building codes. Details are indicative and compliance is the responsibility of the designer. Construction details can vary for wall cladding and framing layout is for indicative purposes only. The building paper is detailed as a single line for simplicity and is indicative only. Building paper type and method of installation should comply with the manufacturers recommendations and the New Zealand Building Code regulations. Profile foam closure strip is only required if bird or vermin proofing is required, or if in a high wind zone there is a risk of wind blown moisture entering the building.

TYPICAL SOFFIT FLASHING DETAIL

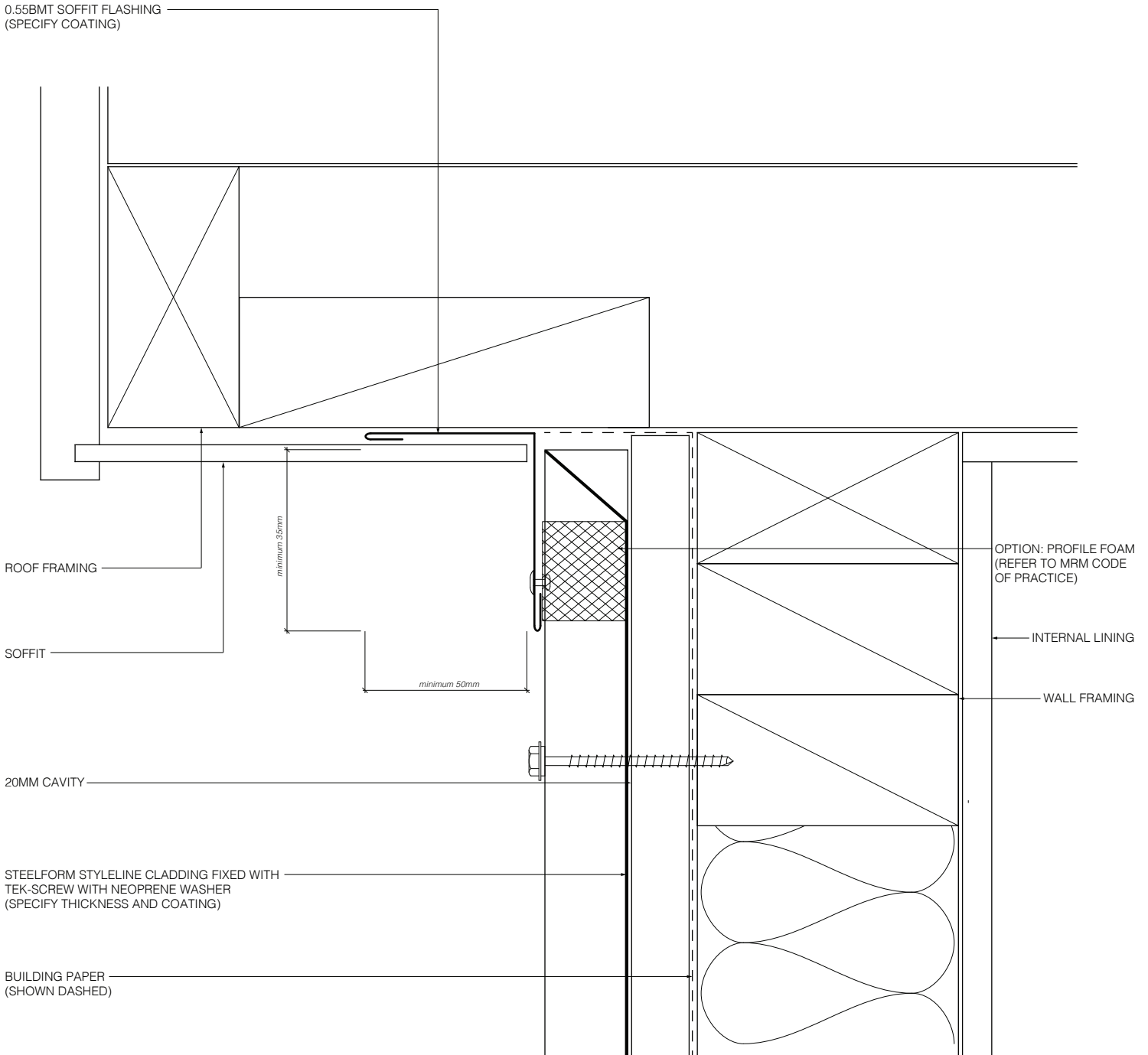

LONGRUN ROOFING MANUFACTURES
TARANAKI STEELFORMERS LTD.

JANUARY 2020 / V1

STYLELINE (CAVITY FIX)

RESIDENTIAL CLADDING

NOT TO SCALE

Disclaimer:
 All details are indicative only and the designer should refer to the NZMRM Code of Practice, E2/AS1 and all other relevant building codes. Details are indicative and compliance is the responsibility of the designer. Construction details can vary for wall cladding and framing layout is for indicative purposes only. The building paper is detailed as a single line for simplicity and is indicative only. Building paper type and method of installation should comply with the manufacturers recommendations and the New Zealand Building Code regulations. Profile foam closure strip is only required if bird or vermin proofing is required, or if in a high wind zone there is a risk of wind blown moisture entering the building.

TYPICAL BARGE FLASHING DETAIL

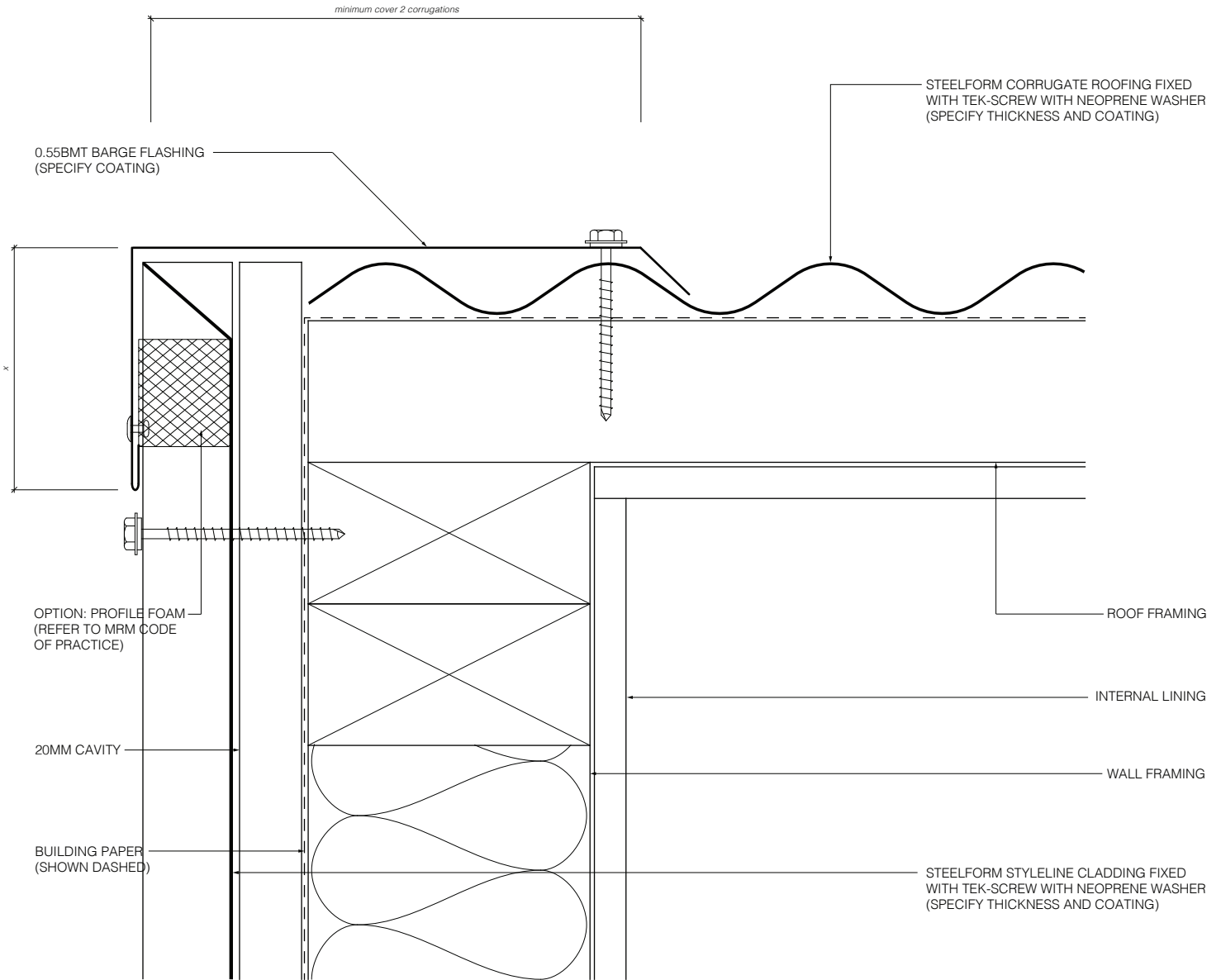

	SITUATION 1 LOW/MEDIUM/HIGH WIND ZONES, AND ROOF PITCH IS 10° AND ABOVE	SITUATION 2 VERY HIGH WIND ZONE. ALL ROOF PITCHES	SITUATION 3 EXTRA HIGH WIND ZONE, ALL ROOF PITCHES
x=	50mm	70mm	90mm
PLEASE REFER TO E2/AS1 TABLE 7 FOR FURTHER INFORMATION ON FLASHING COVER WIDTHS			
	CATEGORY A LOW/MEDIUM/HIGH WIND ZONES, AND WHERE THE PITCH IS NO LESS THAN 10°	CATEGORY B VERY HIGH/EXTRA HIGH WIND ZONES, OR WHERE THE PITCH IS LESS THAN 10°	
x=	Vertically down face (smooth) = min 50mm Vertically down face (profiled) = min 75mm	Vertically down face (smooth) = min 75mm Vertically down face (profiled) = min 100mm	
PLEASE REFER TO THE NZ MRM CODE OF PRACTICE FOR FURTHER INFORMATION ON FLASHING COVER WIDTHS			



LONGRUN ROOFING MANUFACTURES

TARANAKI STEELFORMERS LTD.

STYLELINE (CAVITY FIX)

JANUARY 2020 / V1

RESIDENTIAL CLADDING

NOT TO SCALE

Disclaimer:
All details are indicative only and the designer should refer to the NZMRM Code of Practice, E2/AS1 and all other relevant building codes. Details are indicative and compliance is the responsibility of the designer. Construction details can vary for wall cladding and framing layout is for indicative purposes only. The building paper is detailed as a single line for simplicity and is indicative only. Building paper type and method of installation should comply with the manufacturers recommendations and the New Zealand Building Code regulations. Profile foam closure strip is only required if bird or vermin proofing is required, or if in a high wind zone there is a risk of wind blown moisture entering the building.

TYPICAL PARAPET FLASHING DETAIL

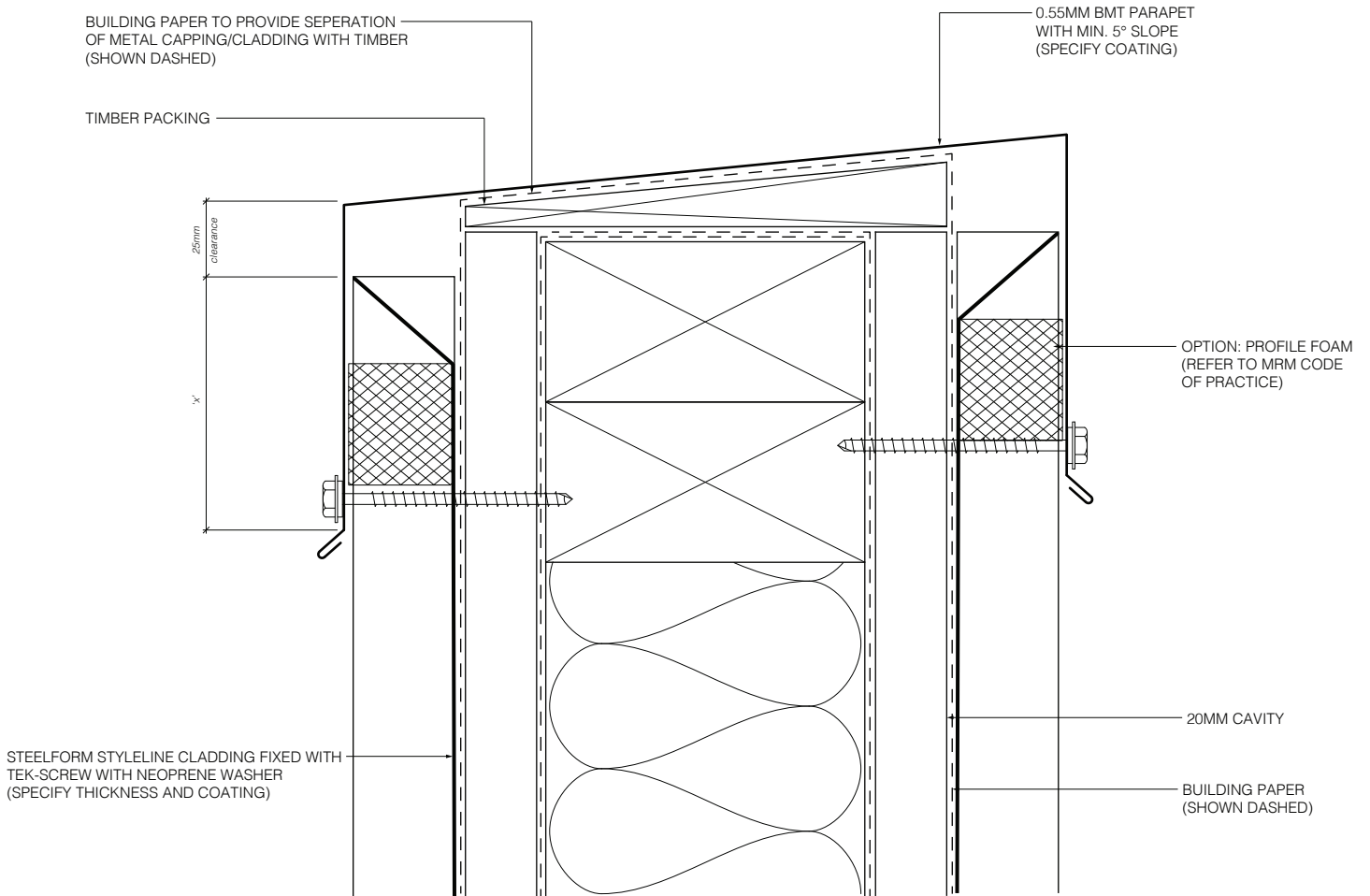

	<p>SITUATION 1 LOW/MEDIUM/HIGH WIND ZONES, AND ROOF PITCH IS 10° AND ABOVE</p>	<p>SITUATION 2 VERY HIGH WIND ZONE. ALL ROOF PITCHES</p>	<p>SITUATION 3 EXTRA HIGH WIND ZONE, ALL ROOF PITCHES</p>
x=	min 50mm	min 70mm	min 90mm
PLEASE REFER TO E2/AS1 TABLE 7 FOR FURTHER INFORMATION ON FLASHING COVER WIDTHS			
	<p>CATEGORY A LOW/MEDIUM/HIGH WIND ZONES, AND WHERE THE PITCH IS NO LESS THAN 10°</p>	<p>CATEGORY B VERY HIGH/EXTRA HIGH WIND ZONES. OR WHERE THE PITCH IS LESS THAN 10°</p>	
x=	Vertically down face (smooth) = min 50mm Vertically down face (profiled) = min 75mm	Vertically down face (smooth) = min 75mm Vertically down face (profiled) = min 100mm	
PLEASE REFER TO THE NZ MRM CODE OF PRACTICE FOR FURTHER INFORMATION ON FLASHING COVER WIDTHS			



LONGRUN ROOFING MANUFACTURES

TARANAKI STEELFORMERS LTD.

STYLELINE (CAVITY FIX)

JANUARY 2020 / V1

RESIDENTIAL CLADDING

NOT TO SCALE

Disclaimer:
All details are indicative only and the designer should refer to the NZMRM Code of Practice, E2/AS1 and all other relevant building codes. Details are indicative and compliance is the responsibility of the designer. Construction details can vary for wall cladding and framing layout is for indicative purposes only. The building paper is detailed as a single line for simplicity and is indicative only. Building paper type and method of installation should comply with the manufacturers recommendations and the New Zealand Building Code regulations. Profile foam closure strip is only required if bird or vermin proofing is required, or if in a high wind zone there is a risk of wind blown moisture entering the building.

TYPICAL WINDOW & DOOR FLASHING DETAILS

Head flashing

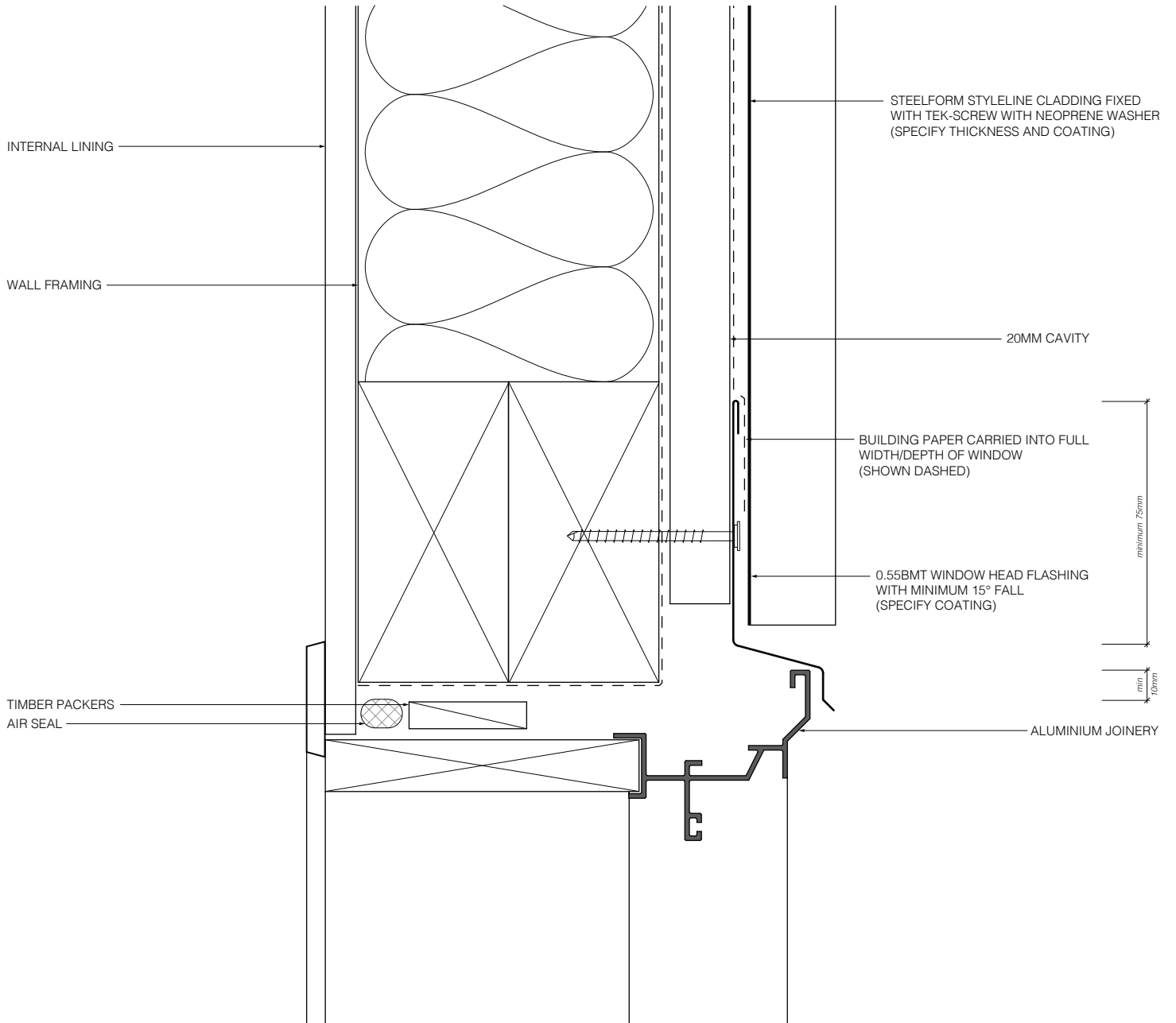

LONGRUN ROOFING MANUFACTURES

TARANAKI STEELFORMERS LTD.

JANUARY 2020 / V1

STYLELINE (CAVITY FIX)

RESIDENTIAL CLADDING

NOT TO SCALE

Disclaimer:
 All details are indicative only and the designer should refer to the NZMRM Code of Practice, E2/AS1 and all other relevant building codes. Details are indicative and compliance is the responsibility of the designer. Construction details can vary for wall cladding and framing layout is for indicative purposes only. The building paper is detailed as a single line for simplicity and is indicative only. Building paper type and method of installation should comply with the manufacturers recommendations and the New Zealand Building Code regulations. Profile foam closure strip is only required if bird or vermin proofing is required, or if in a high wind zone there is a risk of wind blown moisture entering the building.

TYPICAL WINDOW & DOOR FLASHING DETAILS

Jamb flashing

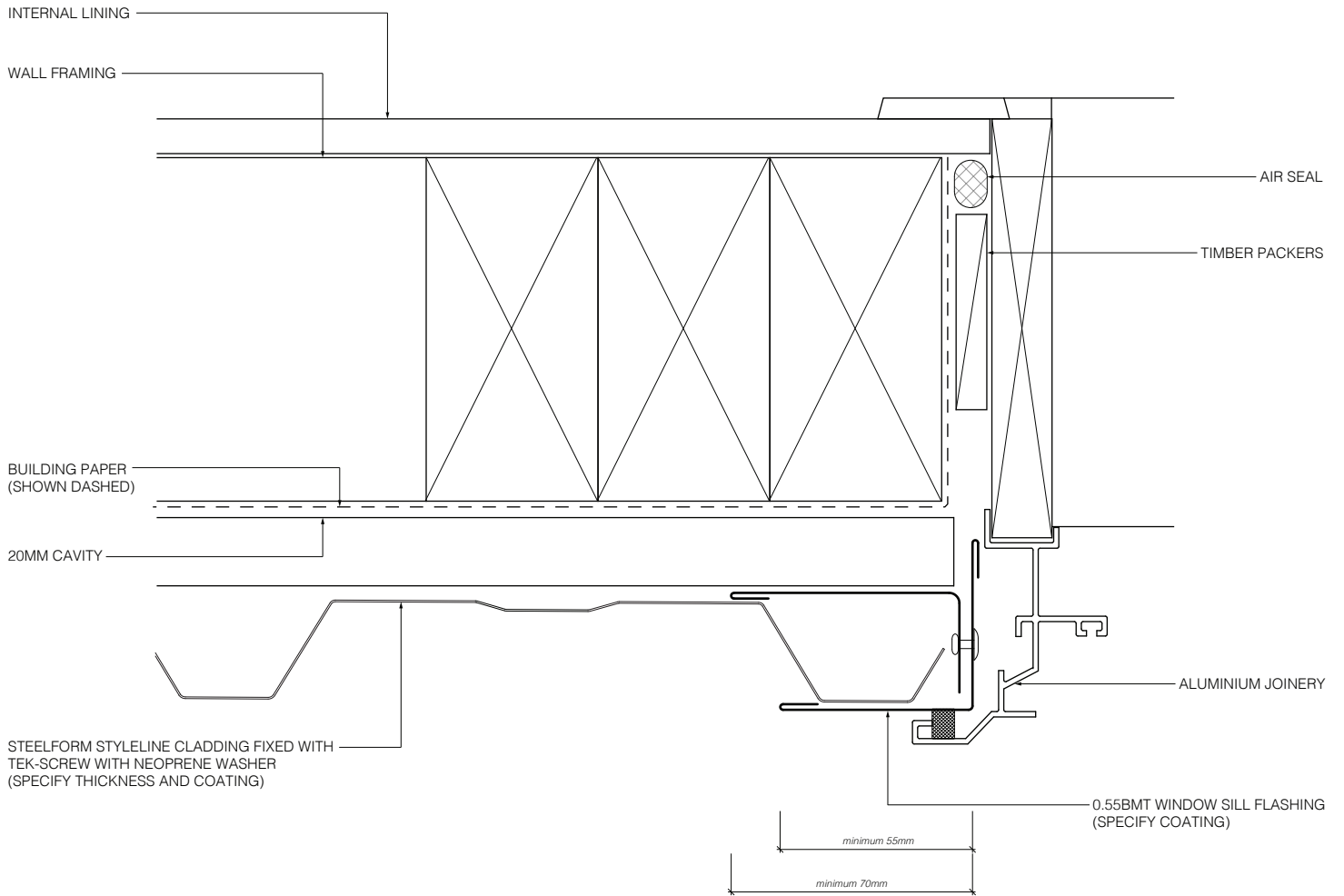

LONGRUN ROOFING MANUFACTURES

TARANAKI STEELFORMERS LTD.

JANUARY 2020 / V1

STYLELINE (CAVITY FIX)

RESIDENTIAL CLADDING

NOT TO SCALE

Disclaimer:
 All details are indicative only and the designer should refer to the NZMRM Code of Practice, E2/AS1 and all other relevant building codes. Details are indicative and compliance is the responsibility of the designer. Construction details can vary for wall cladding and framing layout is for indicative purposes only. The building paper is detailed as a single line for simplicity and is indicative only. Building paper type and method of installation should comply with the manufacturers recommendations and the New Zealand Building Code regulations. Profile foam closure strip is only required if bird or vermin proofing is required, or if in a high wind zone there is a risk of wind blown moisture entering the building.

TYPICAL SOAKER FLASHING DETAIL

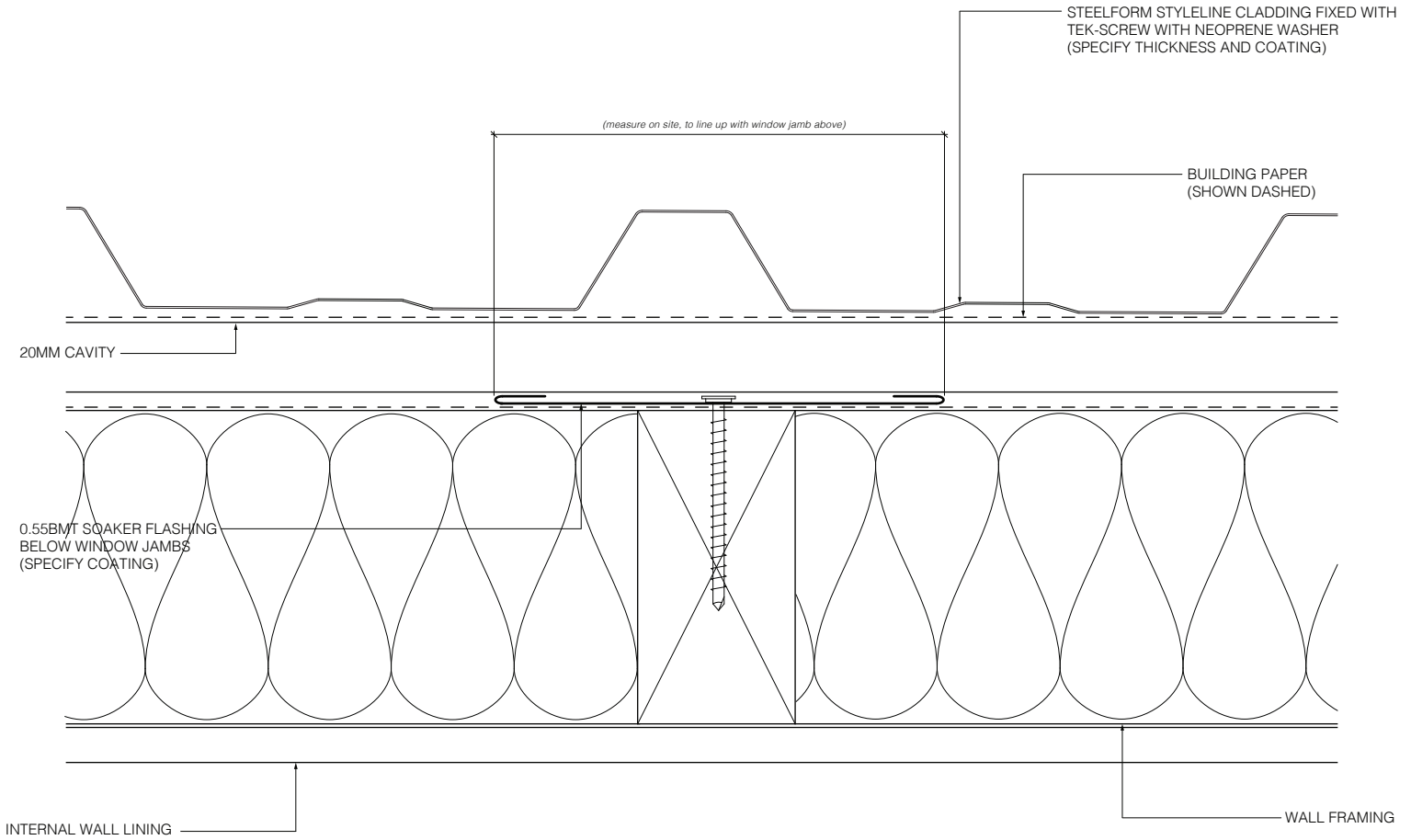

LONGRUN ROOFING MANUFACTURES

TARANAKI STEELFORMERS LTD.

JANUARY 2020 / V1

STYLELINE (CAVITY FIX)

RESIDENTIAL CLADDING

NOT TO SCALE

Disclaimer:
 All details are indicative only and the designer should refer to the NZMRM Code of Practice, E2/AS1 and all other relevant building codes. Details are indicative and compliance is the responsibility of the designer. Construction details can vary for wall cladding and framing layout is for indicative purposes only. The building paper is detailed as a single line for simplicity and is indicative only. Building paper type and method of installation should comply with the manufacturers recommendations and the New Zealand Building Code regulations. Profile foam closure strip is only required if bird or vermin proofing is required, or if in a high wind zone there is a risk of wind blown moisture entering the building.

TYPICAL WINDOW & DOOR FLASHING DETAILS

Sill flashing

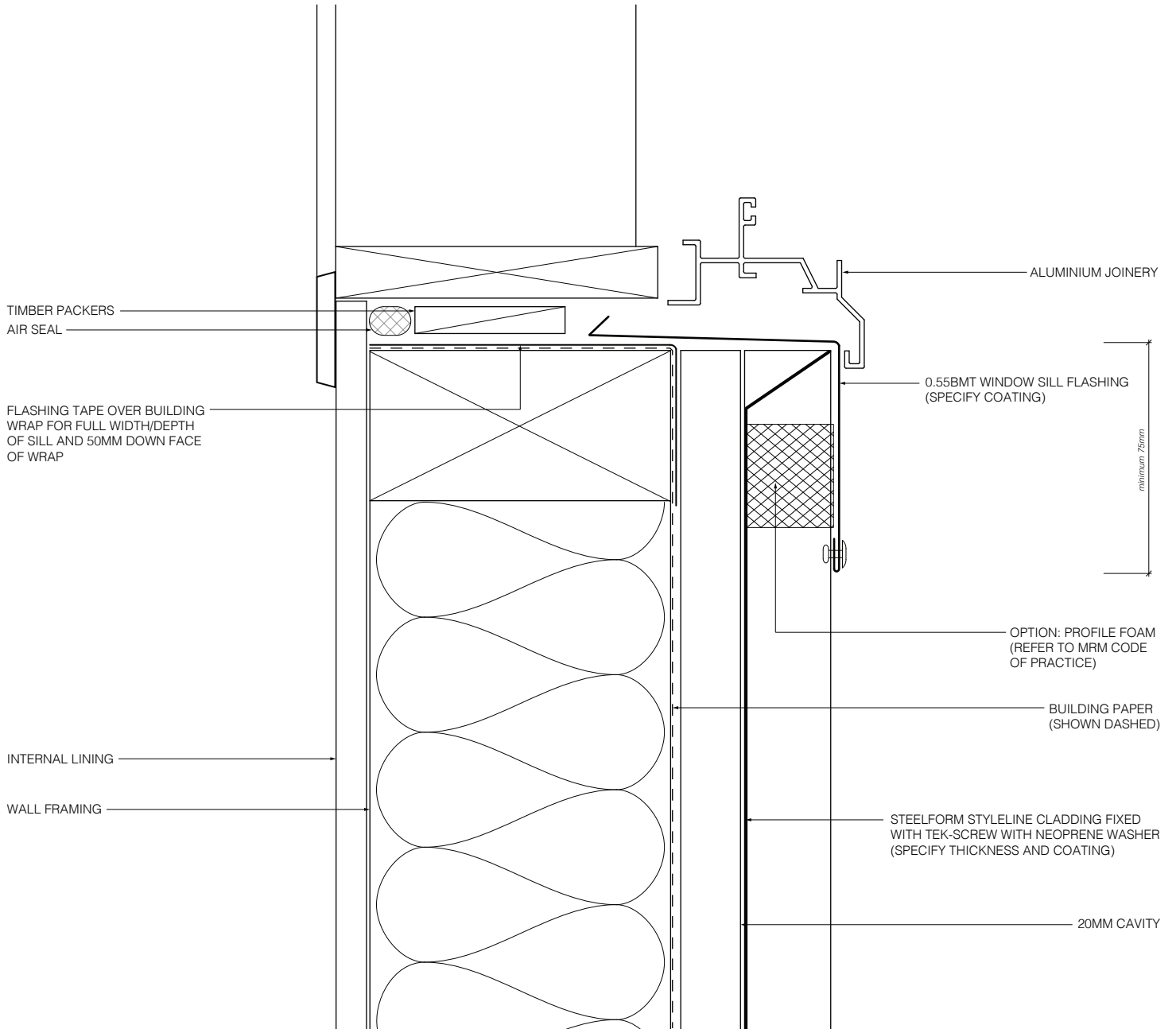

LONGRUN ROOFING MANUFACTURES

TARANAKI STEELFORMERS LTD.

JANUARY 2020 / V1

STYLELINE (CAVITY FIX)

RESIDENTIAL CLADDING

NOT TO SCALE

Disclaimer:
 All details are indicative only and the designer should refer to the NZMRM Code of Practice, E2/AS1 and all other relevant building codes. Details are indicative and compliance is the responsibility of the designer. Construction details can vary for wall cladding and framing layout is for indicative purposes only. The building paper is detailed as a single line for simplicity and is indicative only. Building paper type and method of installation should comply with the manufacturers recommendations and the New Zealand Building Code regulations. Profile foam closure strip is only required if bird or vermin proofing is required, or if in a high wind zone there is a risk of wind blown moisture entering the building.

TYPICAL EXTERNAL CORNER FLASHING DETAIL

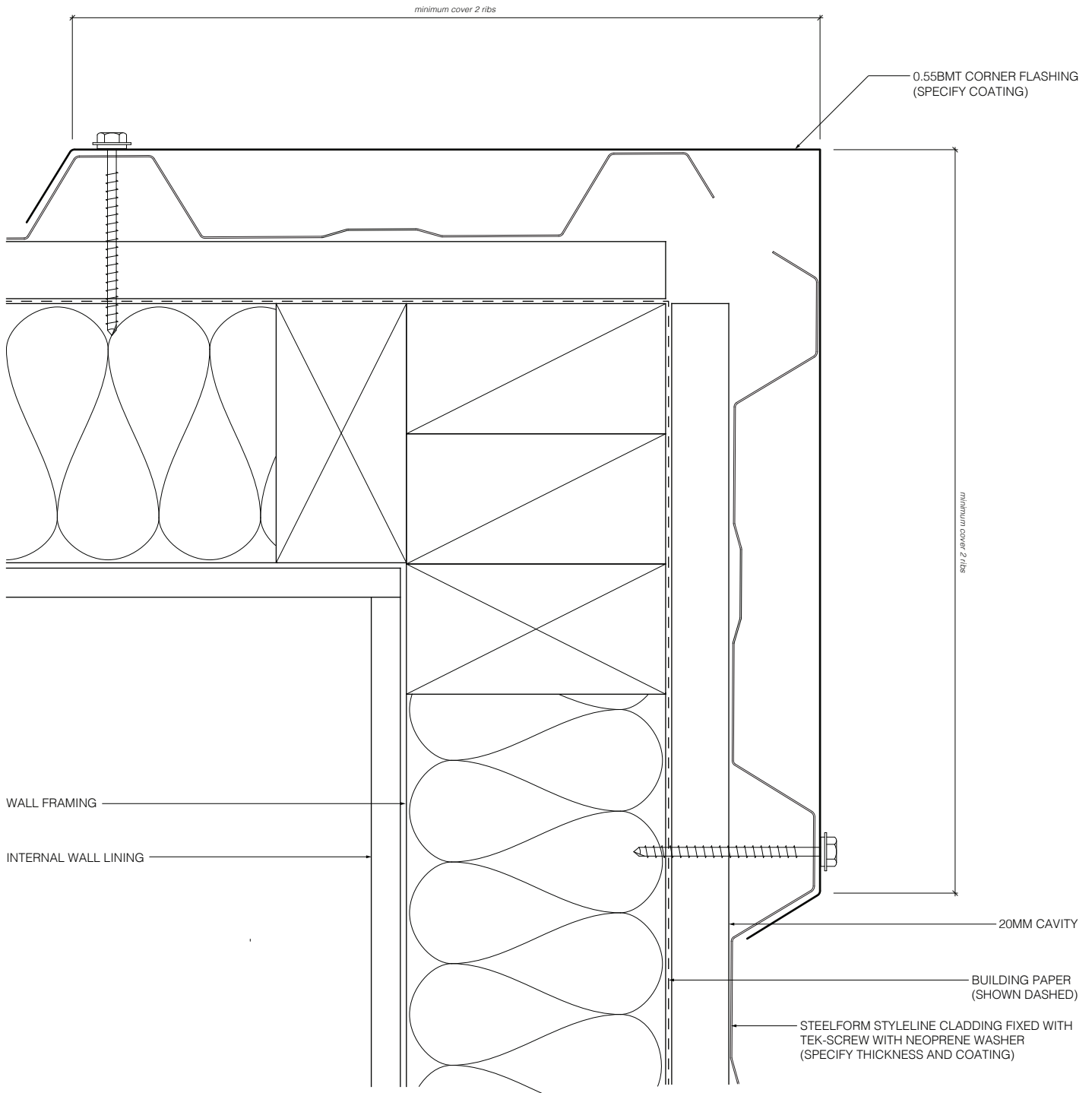

LONGRUN ROOFING MANUFACTURES
TARANAKI STEELFORMERS LTD.

STYLELINE (CAVITY FIX)

JANUARY 2020 / V1

RESIDENTIAL VERTICAL CLADDING

NOT TO SCALE

Disclaimer:
 All details are indicative only and the designer should refer to the NZMRM Code of Practice, E2/AS1 and all other relevant building codes. Details are indicative and compliance is the responsibility of the designer. Construction details can vary for wall cladding and framing layout is for indicative purposes only. The building paper is detailed as a single line for simplicity and is indicative only. Building paper type and method of installation should comply with the manufacturers recommendations and the New Zealand Building Code regulations. Profile foam closure strip is only required if bird or vermin proofing is required, or if in a high wind zone there is a risk of wind blown moisture entering the building.

TYPICAL INTERNAL CORNER FLASHING DETAIL

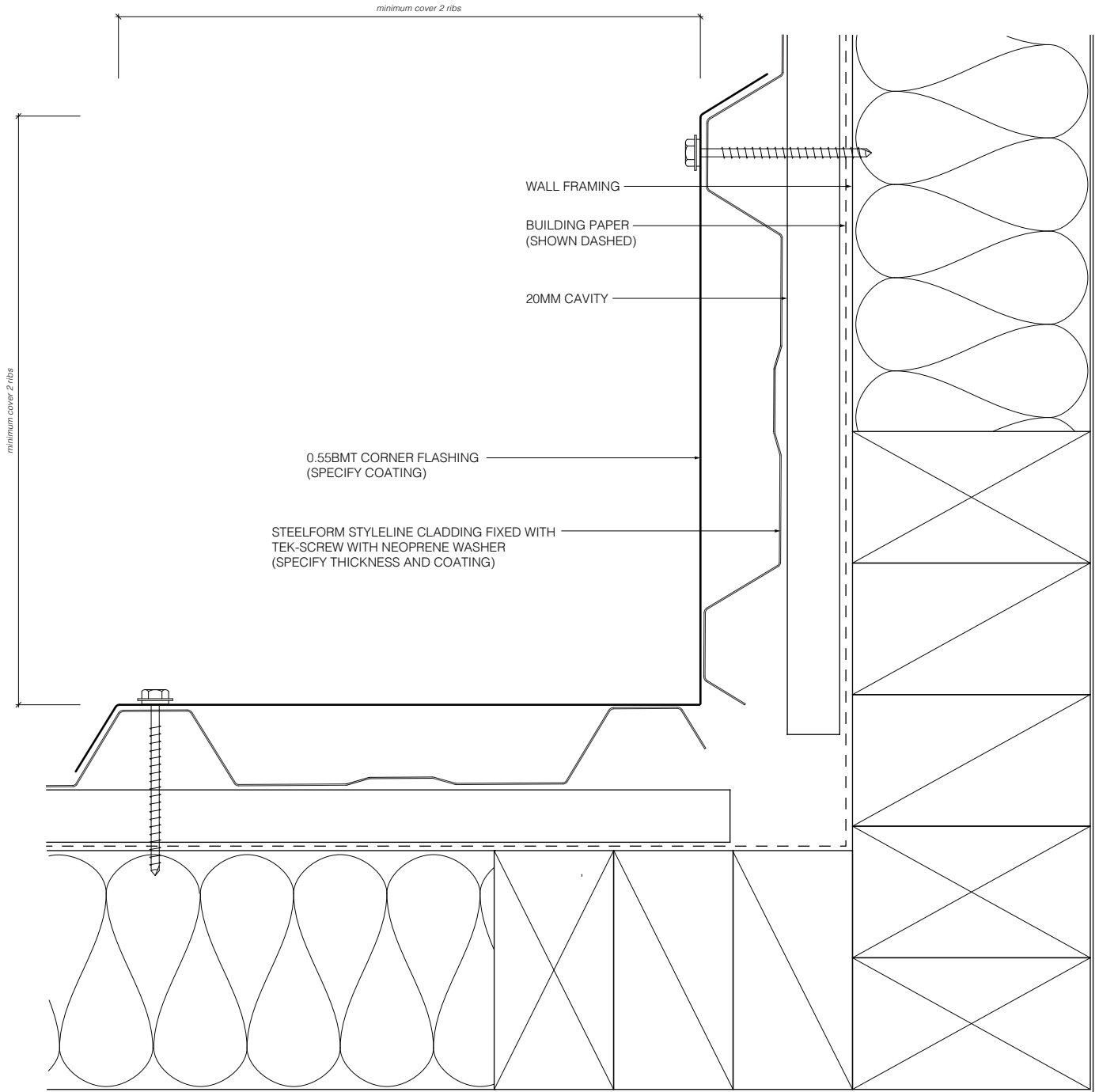

LONGRUN ROOFING MANUFACTURES
TARANAKI STEELFORMERS LTD.

JANUARY 2020 / V1

STYLELINE (CAVITY FIX)

RESIDENTIAL VERTICAL CLADDING

NOT TO SCALE

Disclaimer:
 All details are indicative only and the designer should refer to the NZMRM Code of Practice, E2/AS1 and all other relevant building codes. Details are indicative and compliance is the responsibility of the designer. Construction details can vary for wall cladding and framing layout is for indicative purposes only. The building paper is detailed as a single line for simplicity and is indicative only. Building paper type and method of installation should comply with the manufacturers recommendations and the New Zealand Building Code regulations. Profile foam closure strip is only required if bird or vermin proofing is required, or if in a high wind zone there is a risk of wind blown moisture entering the building.

TYPICAL BOTTOM FLASHING DETAIL

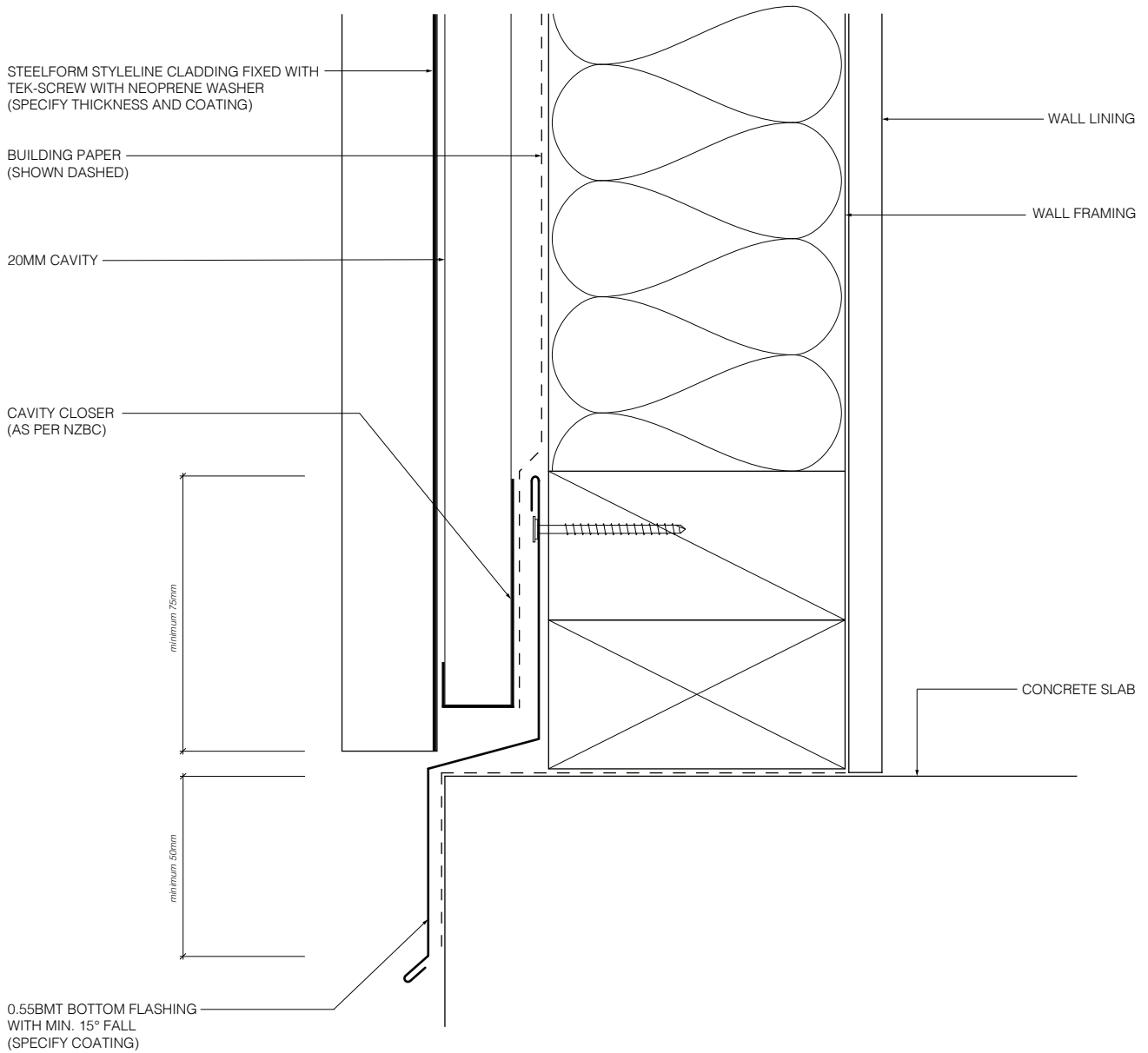

LONGRUN ROOFING MANUFACTURES

TARANAKI STEELFORMERS LTD.

JANUARY 2020 / V1

STYLELINE (CAVITY FIX)

RESIDENTIAL VERTICAL CLADDING

NOT TO SCALE

Disclaimer:
 All details are indicative only and the designer should refer to the NZMRM Code of Practice, E2/AS1 and all other relevant building codes. Details are indicative and compliance is the responsibility of the designer. Construction details can vary for wall cladding and framing layout is for indicative purposes only. The building paper is detailed as a single line for simplicity and is indicative only. Building paper type and method of installation should comply with the manufacturers recommendations and the New Zealand Building Code regulations. Profile foam closure strip is only required if bird or vermin proofing is required, or if in a high wind zone there is a risk of wind blown moisture entering the building.

TYPICAL EAVES FLASHING DETAIL

N.B. Eaves flashings are required where all of the following conditions are met:

- Roof slop is less than or equal to 10°, and
- soffit width is less than or equal to 100mm, and
- wind zones are Very High or Extra High

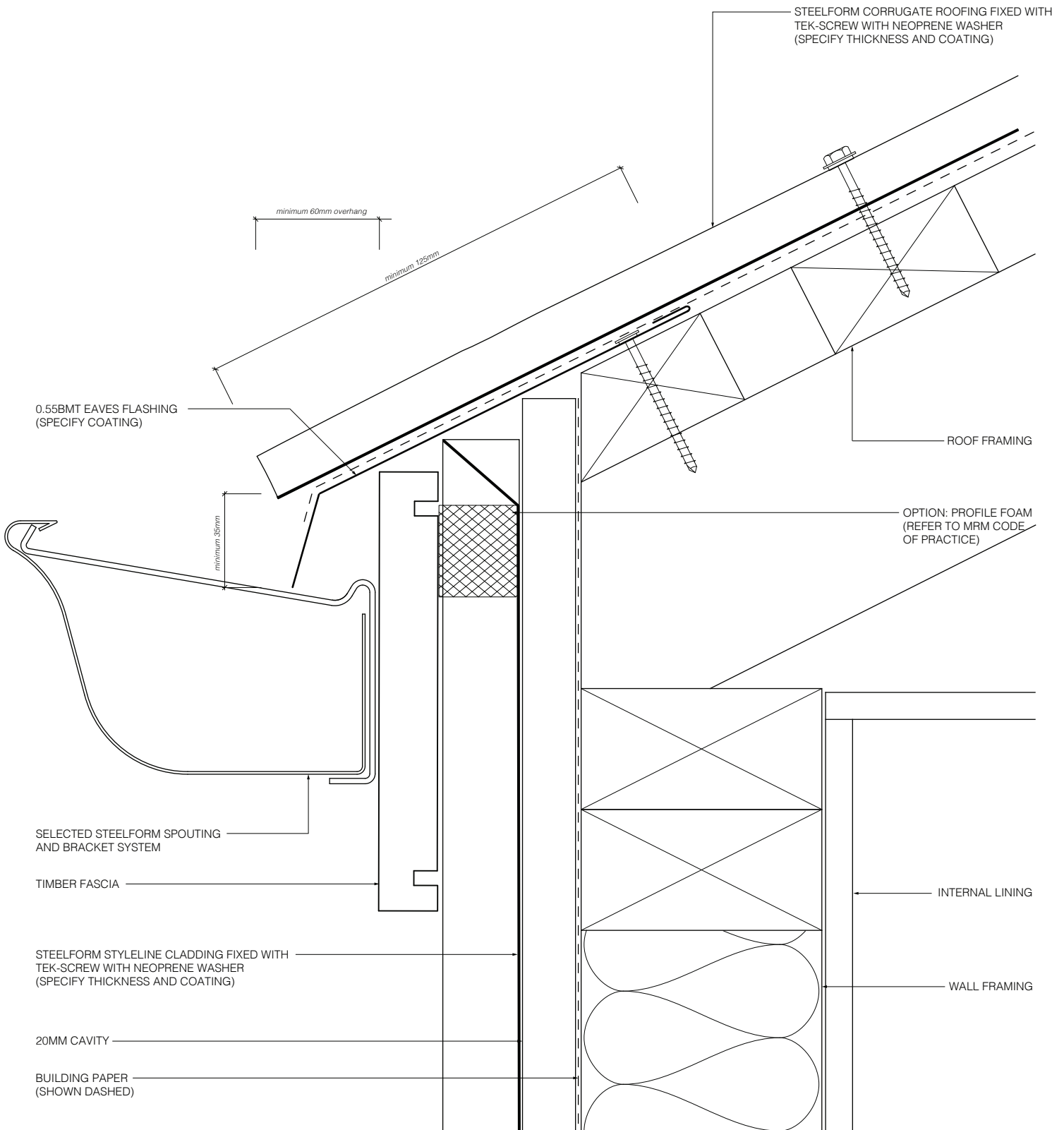

LONGRUN ROOFING MANUFACTURES

TARANAKI STEELFORMERS LTD.

STYLELINE (CAVITY FIX)

JANUARY 2020 / V1

RESIDENTIAL VERTICAL CLADDING

NOT TO SCALE

Disclaimer: All details are indicative only and the designer should refer to the NZMRM Code of Practice, E2/AS1 and all other relevant building codes. Details are indicative and compliance is the responsibility of the designer. Construction details can vary for wall cladding and framing layout is for indicative purposes only. The building paper is detailed as a single line for simplicity and is indicative only. Building paper type and method of installation should comply with the manufacturers recommendations and the New Zealand Building Code regulations. Profile foam closure strip is only required if bird or vermin proofing is required, or if in a high wind zone there is a risk of wind blown moisture entering the building.

TYPICAL FLUSH BARGE FLASHING DETAIL

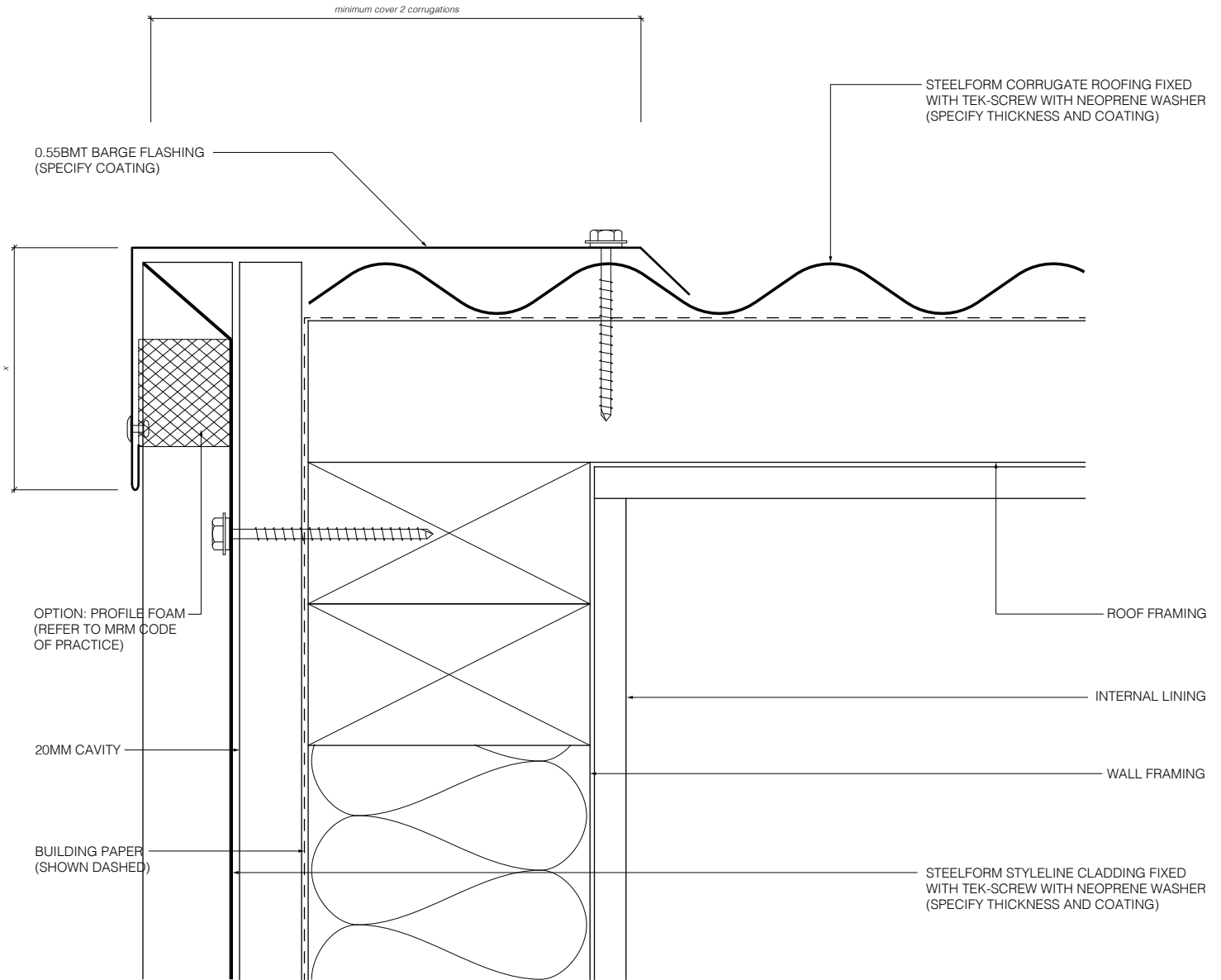

	SITUATION 1 LOW/MEDIUM/HIGH WIND ZONES, AND ROOF PITCH IS 10° AND ABOVE	SITUATION 2 VERY HIGH WIND ZONE. ALL ROOF PITCHES	SITUATION 3 EXTRA HIGH WIND ZONE, ALL ROOF PITCHES
x=	50mm	70mm	90mm
PLEASE REFER TO E2/AS1 TABLE 7 FOR FURTHER INFORMATION ON FLASHING COVER WIDTHS			
	CATEGORY A LOW/MEDIUM/HIGH WIND ZONES, AND WHERE THE PITCH IS NO LESS THAN 10°	CATEGORY B VERY HIGH/EXTRA HIGH WIND ZONES, OR WHERE THE PITCH IS LESS THAN 10°	
x=	Vertically down face (smooth) = min 50mm Vertically down face (profiled) = min 75mm	Vertically down face (smooth) = min 75mm Vertically down face (profiled) = min 100mm	
PLEASE REFER TO THE NZ MRM CODE OF PRACTICE FOR FURTHER INFORMATION ON FLASHING COVER WIDTHS			



LONGRUN ROOFING MANUFACTURES

TARANAKI STEELFORMERS LTD.

STYLELINE (CAVITY FIX)

JANUARY 2020 / V1

RESIDENTIAL VERTICAL CLADDING

NOT TO SCALE

Disclaimer:
All details are indicative only and the designer should refer to the NZMRM Code of Practice, E2/AS1 and all other relevant building codes. Details are indicative and compliance is the responsibility of the designer. Construction details can vary for wall cladding and framing layout is for indicative purposes only. The building paper is detailed as a single line for simplicity and is indicative only. Building paper type and method of installation should comply with the manufacturers recommendations and the New Zealand Building Code regulations. Profile foam closure strip is only required if bird or vermin proofing is required, or if in a high wind zone there is a risk of wind blown moisture entering the building.

TYPICAL SOFFIT FLASHING DETAIL

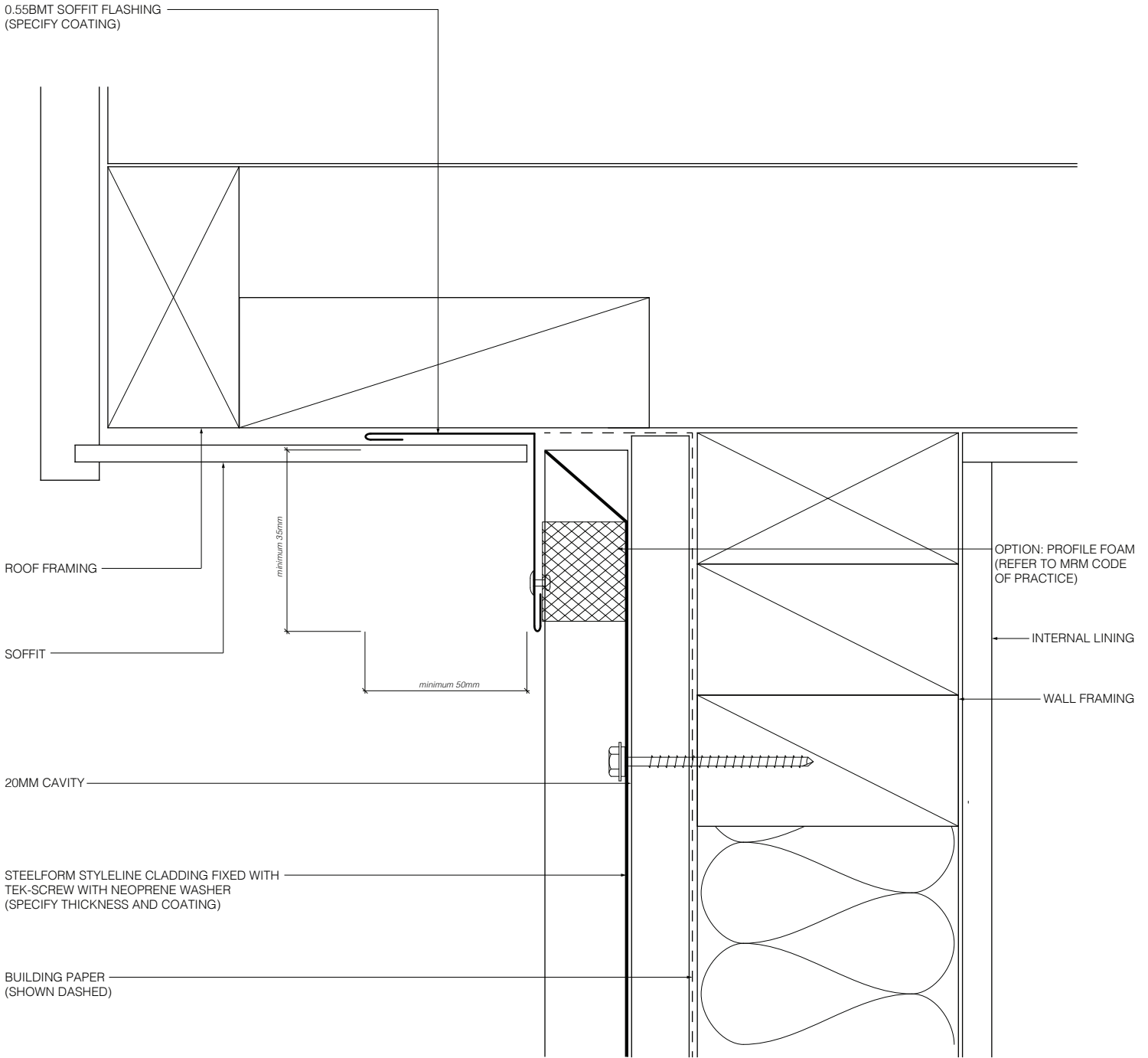

LONGRUN ROOFING MANUFACTURES
TARANAKI STEELFORMERS LTD.

STYLELINE (CAVITY FIX)

JANUARY 2020 / V1

RESIDENTIAL VERTICAL CLADDING

NOT TO SCALE

Disclaimer:
 All details are indicative only and the designer should refer to the NZMRM Code of Practice, E2/AS1 and all other relevant building codes. Details are indicative and compliance is the responsibility of the designer. Construction details can vary for wall cladding and framing layout is for indicative purposes only. The building paper is detailed as a single line for simplicity and is indicative only. Building paper type and method of installation should comply with the manufacturers recommendations and the New Zealand Building Code regulations. Profile foam closure strip is only required if bird or vermin proofing is required, or if in a high wind zone there is a risk of wind blown moisture entering the building.

TYPICAL PARAPET FLASHING DETAIL

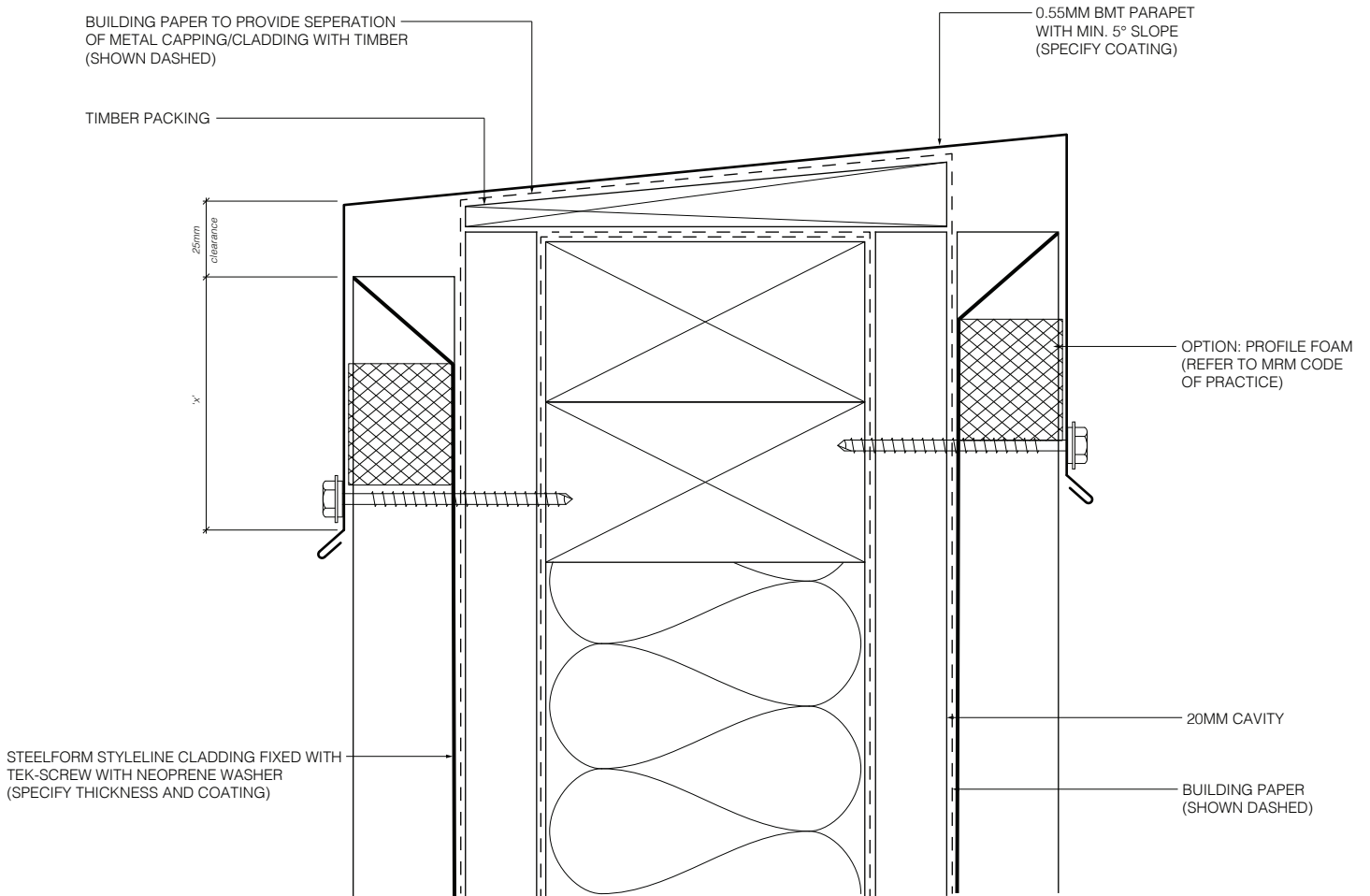

	<p>SITUATION 1 LOW/MEDIUM/HIGH WIND ZONES, AND ROOF PITCH IS 10° AND ABOVE</p>	<p>SITUATION 2 VERY HIGH WIND ZONE. ALL ROOF PITCHES</p>	<p>SITUATION 3 EXTRA HIGH WIND ZONE, ALL ROOF PITCHES</p>
x=	min 50mm	min 70mm	min 90mm
PLEASE REFER TO E2/AS1 TABLE 7 FOR FURTHER INFORMATION ON FLASHING COVER WIDTHS			
	<p>CATEGORY A LOW/MEDIUM/HIGH WIND ZONES, AND WHERE THE PITCH IS NO LESS THAN 10°</p>	<p>CATEGORY B VERY HIGH/EXTRA HIGH WIND ZONES. OR WHERE THE PITCH IS LESS THAN 10°</p>	
x=	Vertically down face (smooth) = min 50mm Vertically down face (profiled) = min 75mm	Vertically down face (smooth) = min 75mm Vertically down face (profiled) = min 100mm	
PLEASE REFER TO THE NZ MRM CODE OF PRACTICE FOR FURTHER INFORMATION ON FLASHING COVER WIDTHS			



LONGRUN ROOFING MANUFACTURES

TARANAKI STEELFORMERS LTD.

STYLELINE (CAVITY FIX)

JANUARY 2020 / V1

RESIDENTIAL VERTICAL CLADDING

NOT TO SCALE

Disclaimer:
All details are indicative only and the designer should refer to the NZMRM Code of Practice, E2/AS1 and all other relevant building codes. Details are indicative and compliance is the responsibility of the designer. Construction details can vary for wall cladding and framing layout is for indicative purposes only. The building paper is detailed as a single line for simplicity and is indicative only. Building paper type and method of installation should comply with the manufacturers recommendations and the New Zealand Building Code regulations. Profile foam closure strip is only required if bird or vermin proofing is required, or if in a high wind zone there is a risk of wind blown moisture entering the building.

TYPICAL WINDOW & DOOR FLASHING DETAILS

Head flashing

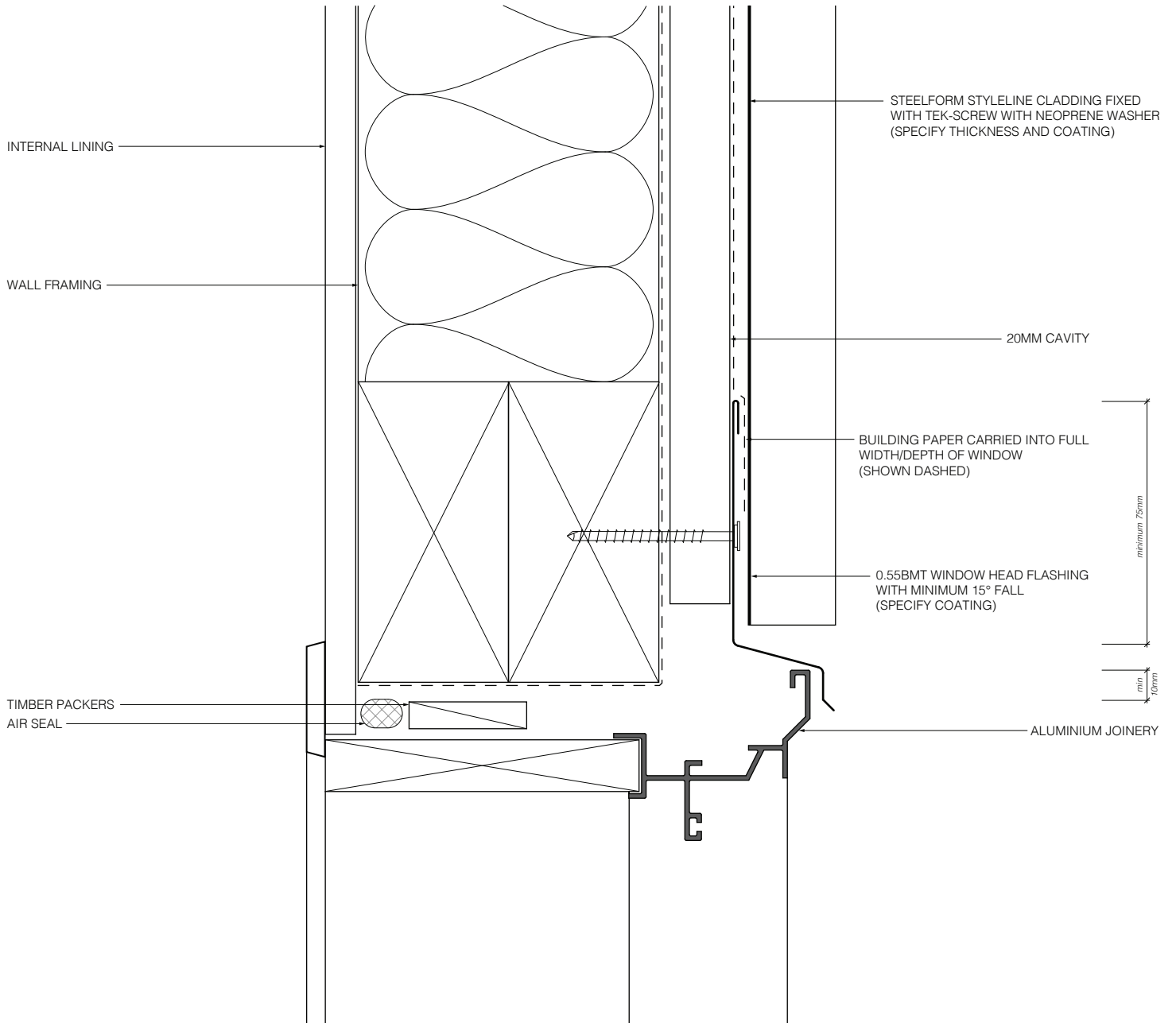

LONGRUN ROOFING MANUFACTURES

TARANAKI STEELFORMERS LTD.

STYLELINE (CAVITY FIX)



JANUARY 2020 / V1

RESIDENTIAL VERTICAL CLADDING

NOT TO SCALE

Disclaimer:
 All details are indicative only and the designer should refer to the NZMRM Code of Practice, E2/AS1 and all other relevant building codes. Details are indicative and compliance is the responsibility of the designer. Construction details can vary for wall cladding and framing layout is for indicative purposes only. The building paper is detailed as a single line for simplicity and is indicative only. Building paper type and method of installation should comply with the manufacturers recommendations and the New Zealand Building Code regulations. Profile foam closure strip is only required if bird or vermin proofing is required, or if in a high wind zone there is a risk of wind blown moisture entering the building.

TYPICAL WINDOW & DOOR FLASHING DETAILS

Jamb flashing

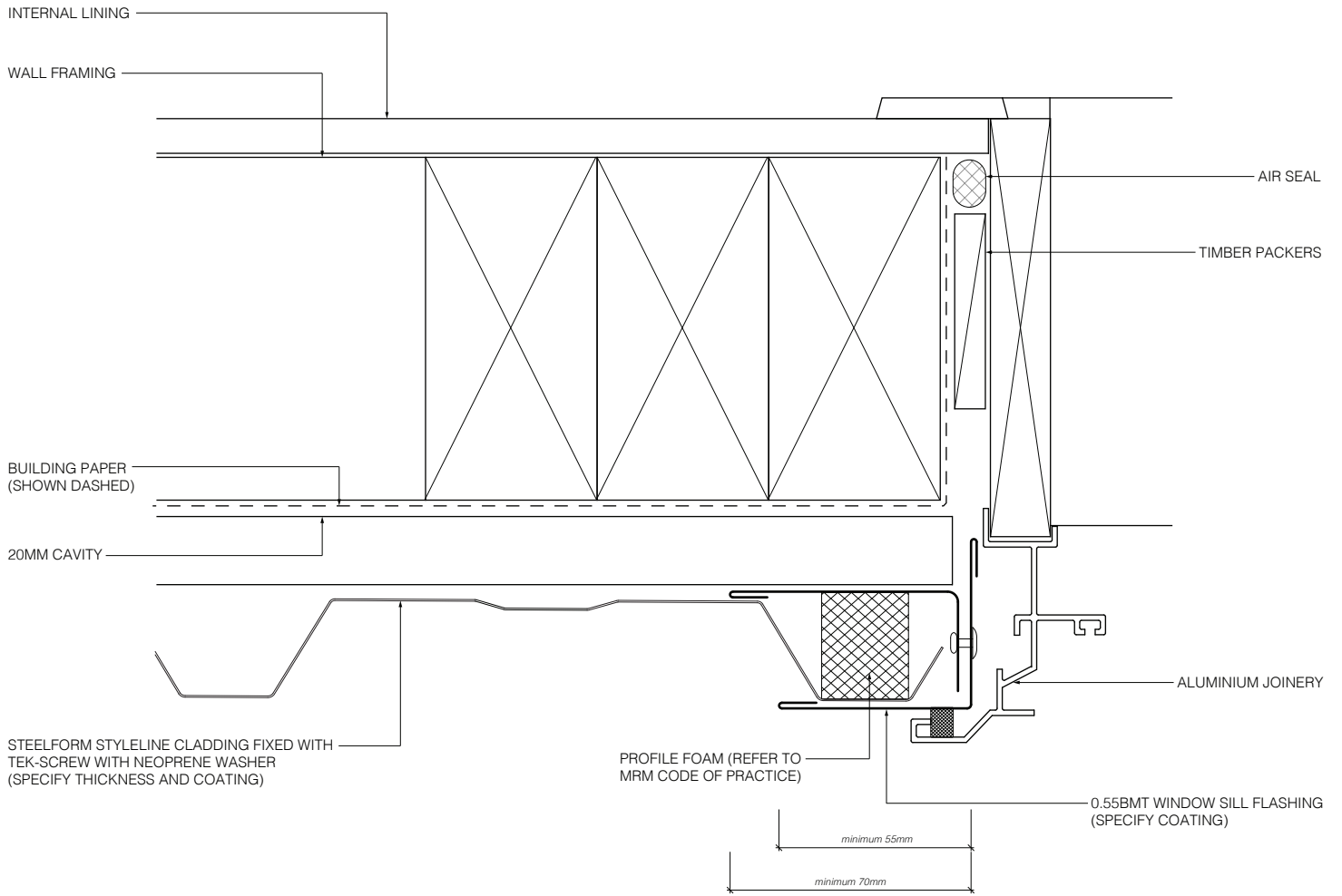

LONGRUN ROOFING MANUFACTURES

TARANAKI STEELFORMERS LTD.

JANUARY 2020 / V1

STYLELINE (CAVITY FIX)

RESIDENTIAL VERTICAL CLADDING

NOT TO SCALE

Disclaimer:
 All details are indicative only and the designer should refer to the NZMRM Code of Practice, E2/AS1 and all other relevant building codes. Details are indicative and compliance is the responsibility of the designer. Construction details can vary for wall cladding and framing layout is for indicative purposes only. The building paper is detailed as a single line for simplicity and is indicative only. Building paper type and method of installation should comply with the manufacturers recommendations and the New Zealand Building Code regulations. Profile foam closure strip is only required if bird or vermin proofing is required, or if in a high wind zone there is a risk of wind blown moisture entering the building.

TYPICAL SOAKER FLASHING DETAIL

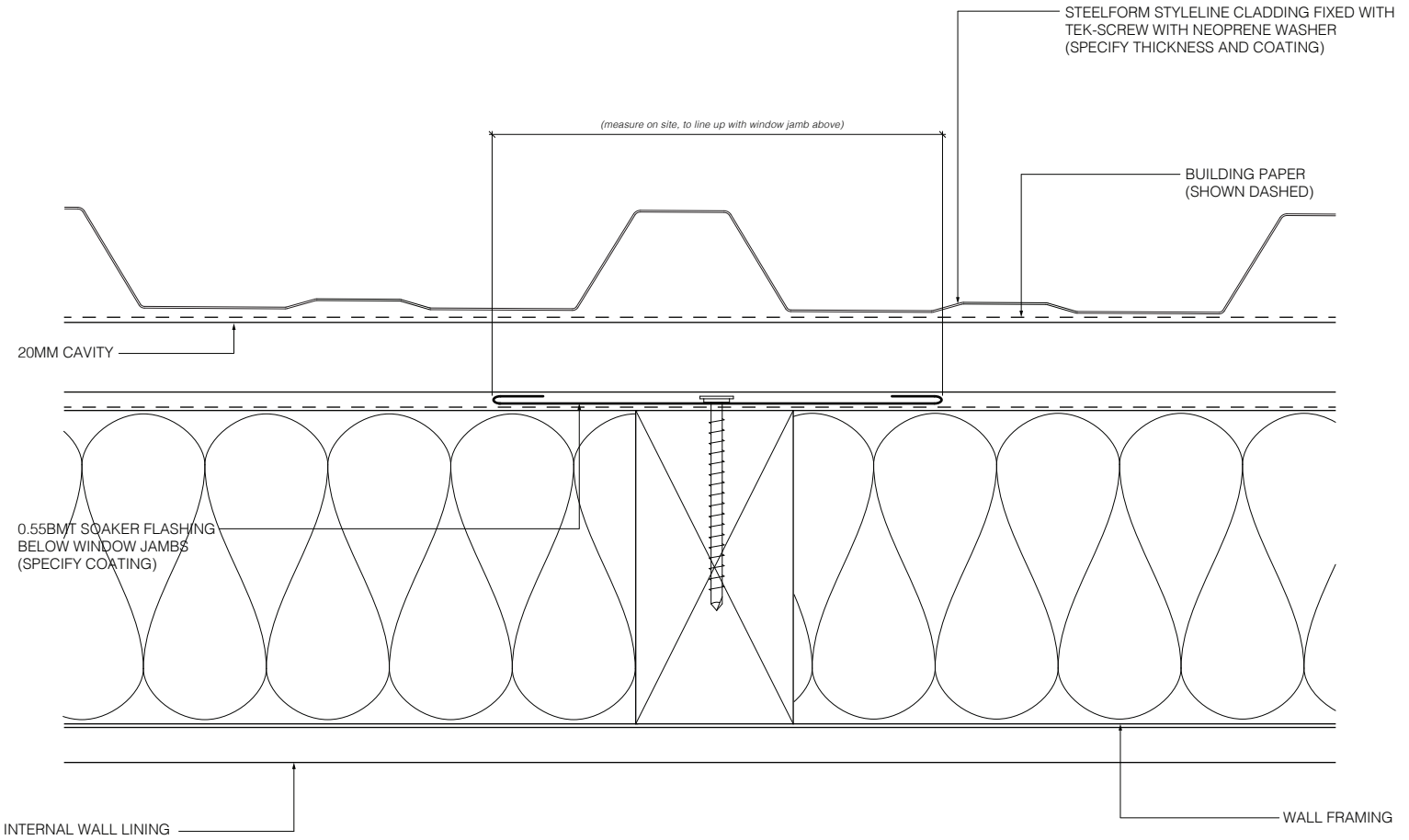

LONGRUN ROOFING MANUFACTURES
TARANAKI STEELFORMERS LTD.

STYLELINE (CAVITY FIX)

JANUARY 2020 / V1

RESIDENTIAL VERTICAL CLADDING

NOT TO SCALE

Disclaimer:
 All details are indicative only and the designer should refer to the NZMRM Code of Practice, E2/AS1 and all other relevant building codes. Details are indicative and compliance is the responsibility of the designer. Construction details can vary for wall cladding and framing layout is for indicative purposes only. The building paper is detailed as a single line for simplicity and is indicative only. Building paper type and method of installation should comply with the manufacturers recommendations and the New Zealand Building Code regulations. Profile foam closure strip is only required if bird or vermin proofing is required, or if in a high wind zone there is a risk of wind blown moisture entering the building.

TYPICAL WINDOW & DOOR FLASHING DETAILS

Sill flashing

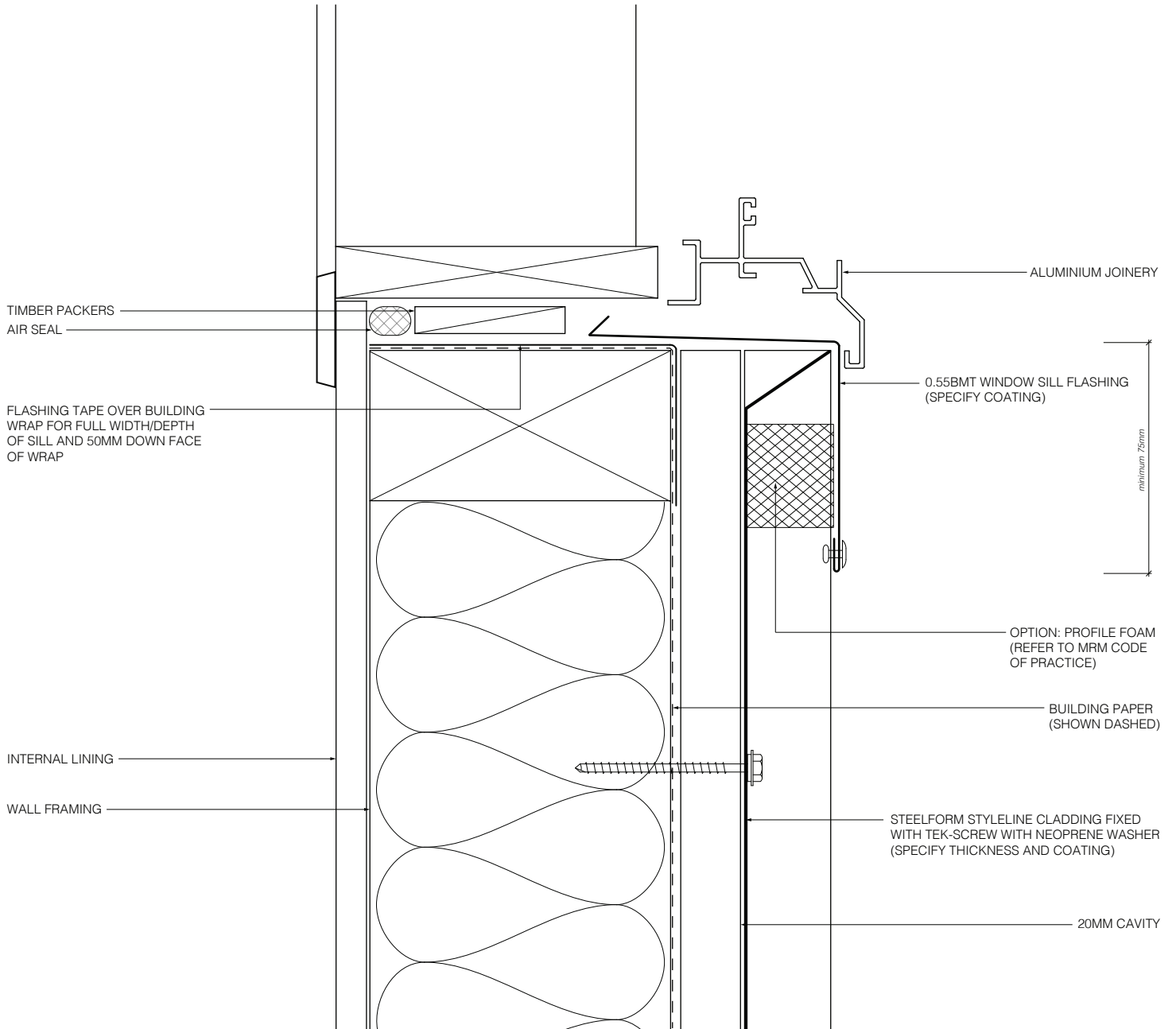

LONGRUN ROOFING MANUFACTURES

TARANAKI STEELFORMERS LTD.

JANUARY 2020 / V1

STYLELINE (CAVITY FIX)

RESIDENTIAL VERTICAL CLADDING

NOT TO SCALE

Disclaimer:
 All details are indicative only and the designer should refer to the NZMRM Code of Practice, E2/AS1 and all other relevant building codes. Details are indicative and compliance is the responsibility of the designer. Construction details can vary for wall cladding and framing layout is for indicative purposes only. The building paper is detailed as a single line for simplicity and is indicative only. Building paper type and method of installation should comply with the manufacturers recommendations and the New Zealand Building Code regulations. Profile foam closure strip is only required if bird or vermin proofing is required, or if in a high wind zone there is a risk of wind blown moisture entering the building.